

**TAILLES**

	34
	36
	38
	40
	42
	44
	46

EMONADE\*

VA  
PE



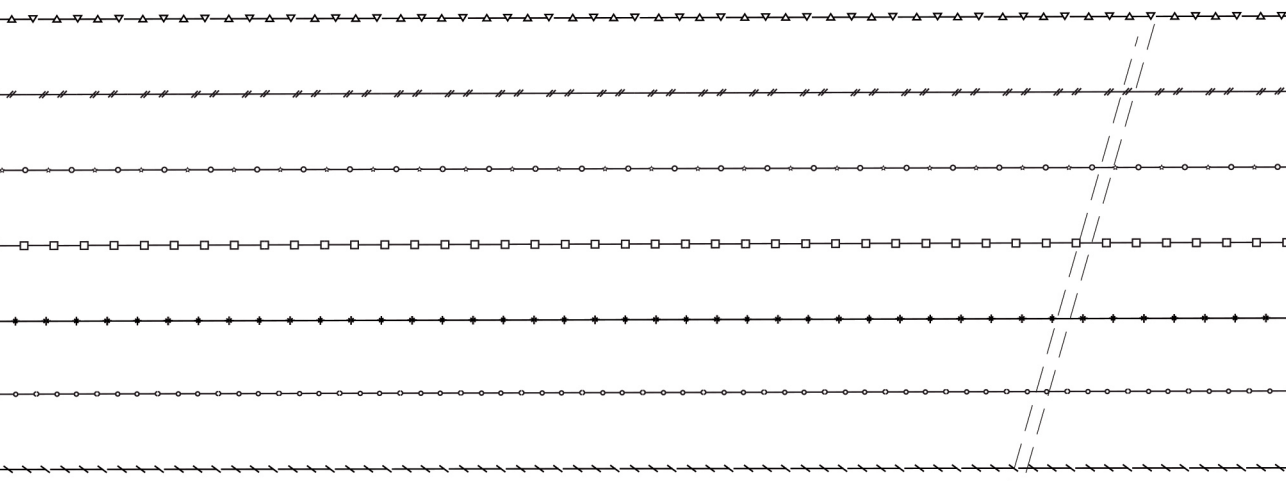

*coupez pour agrandir ou rétrécir ici* 

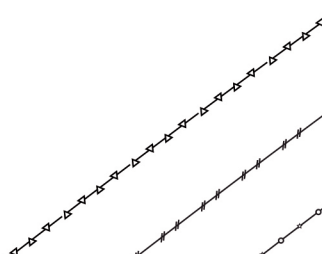
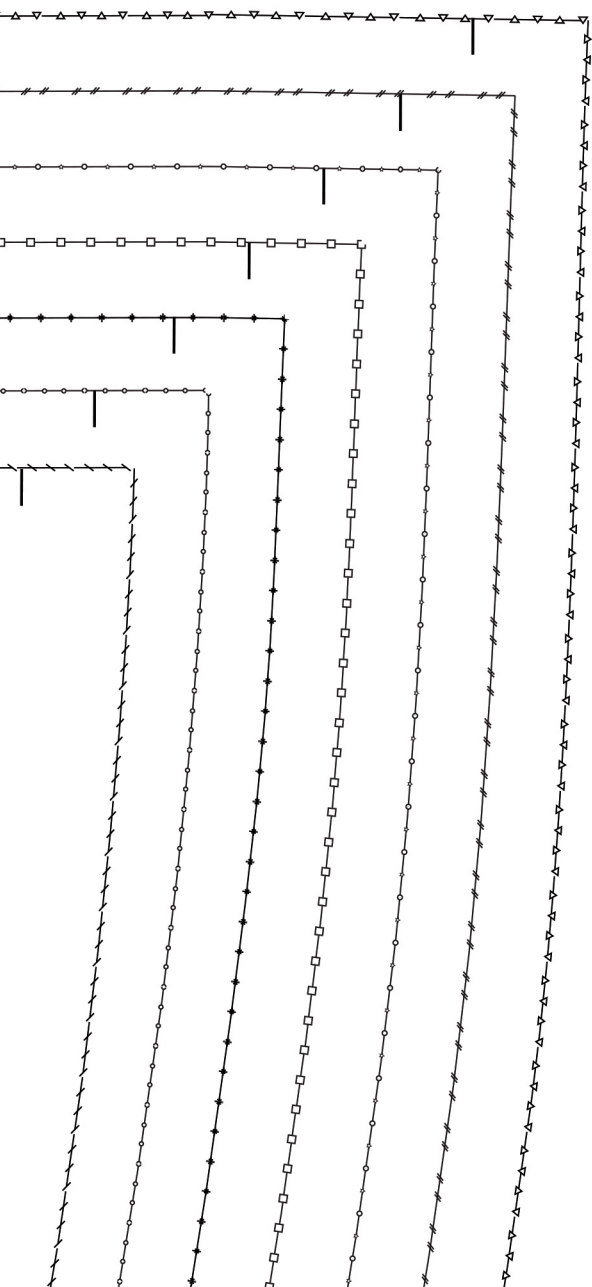

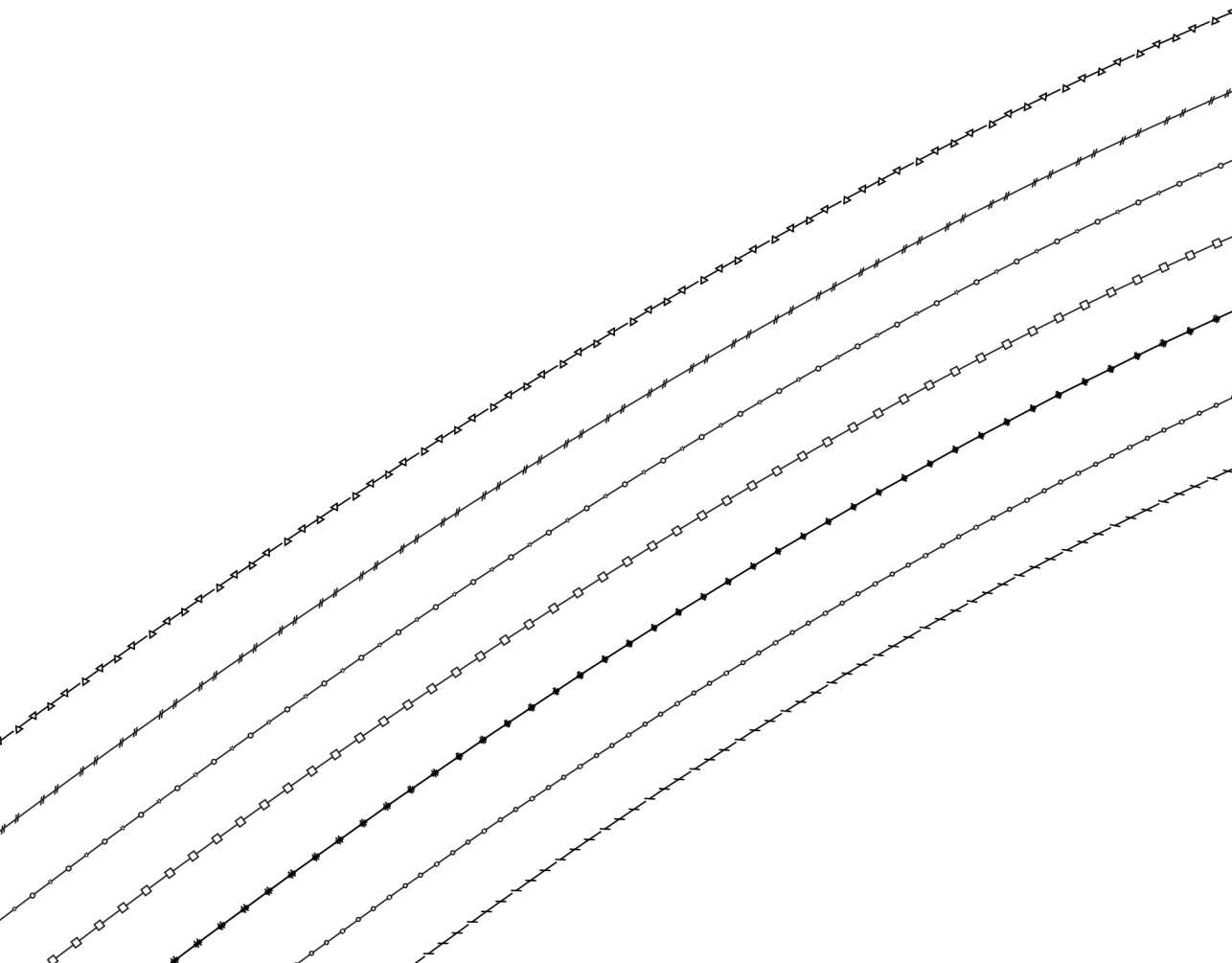

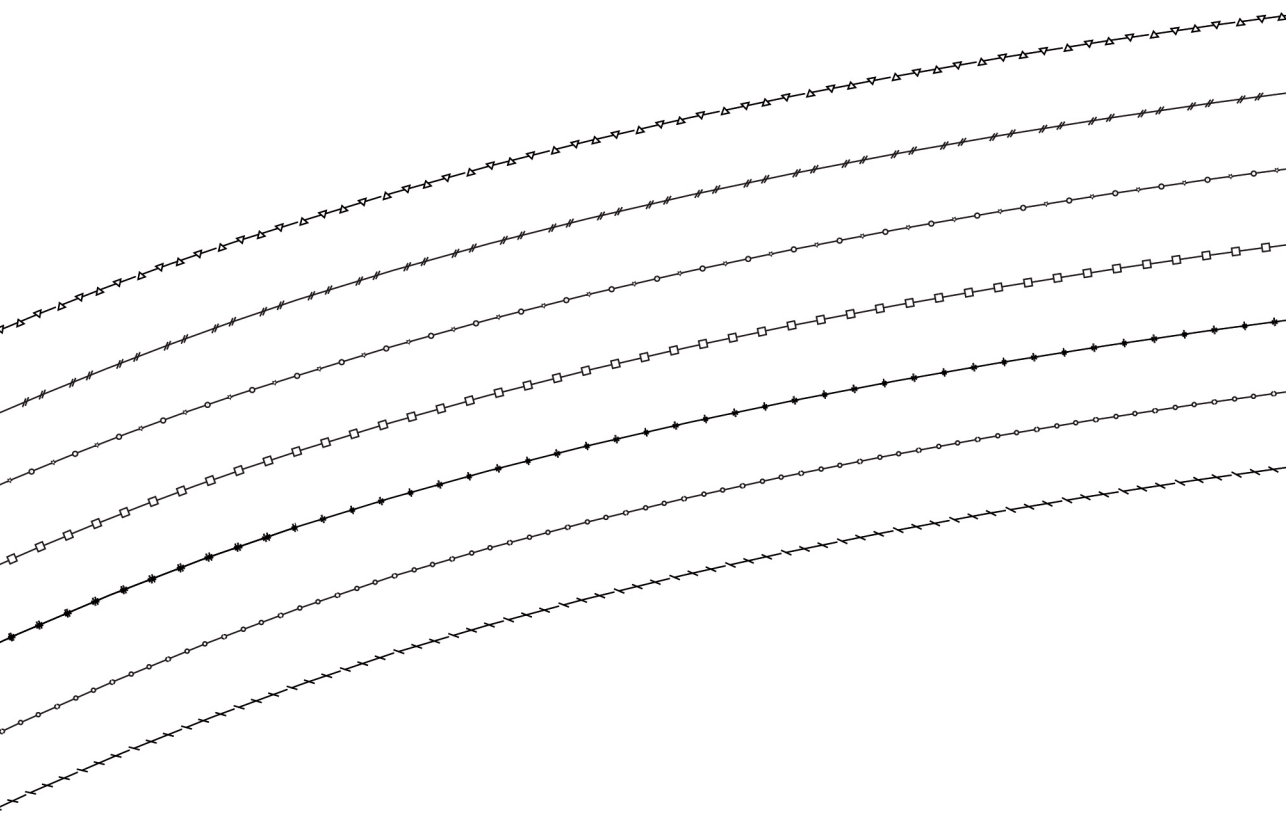

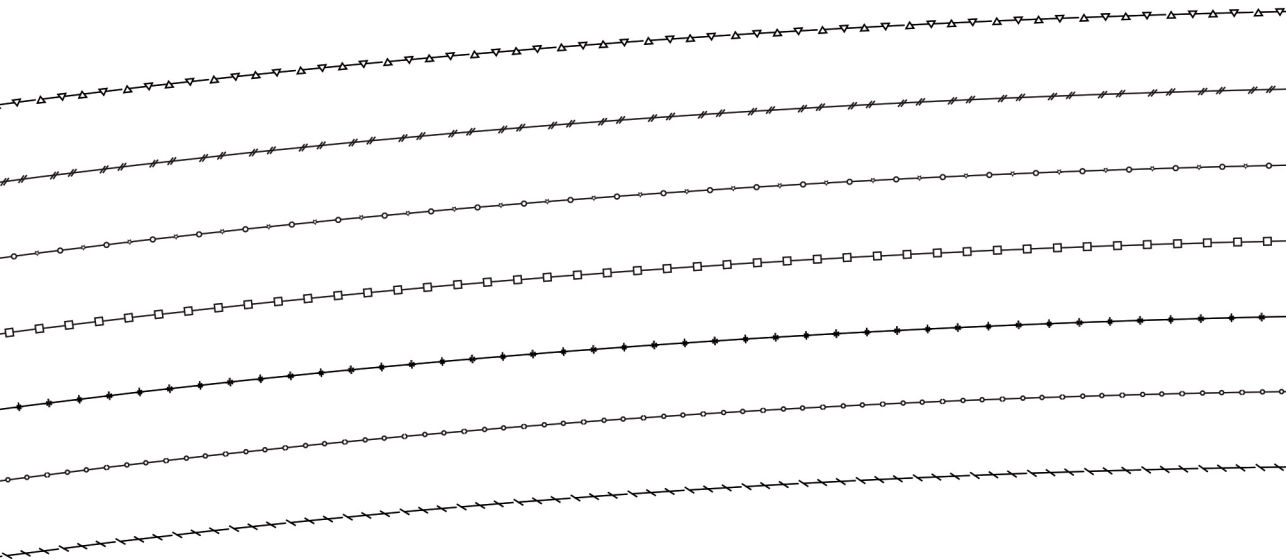

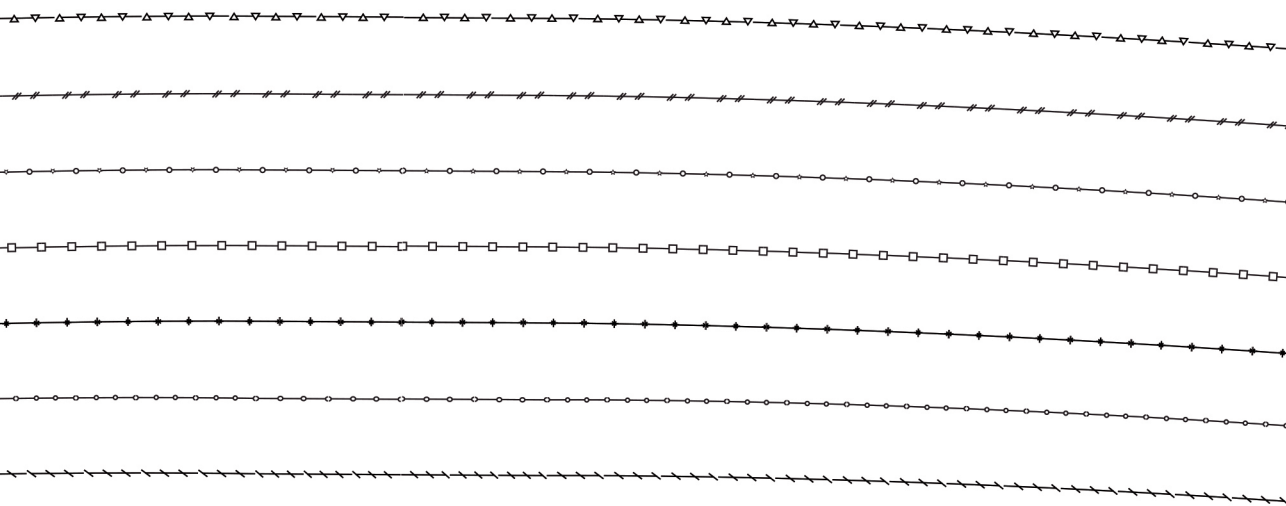

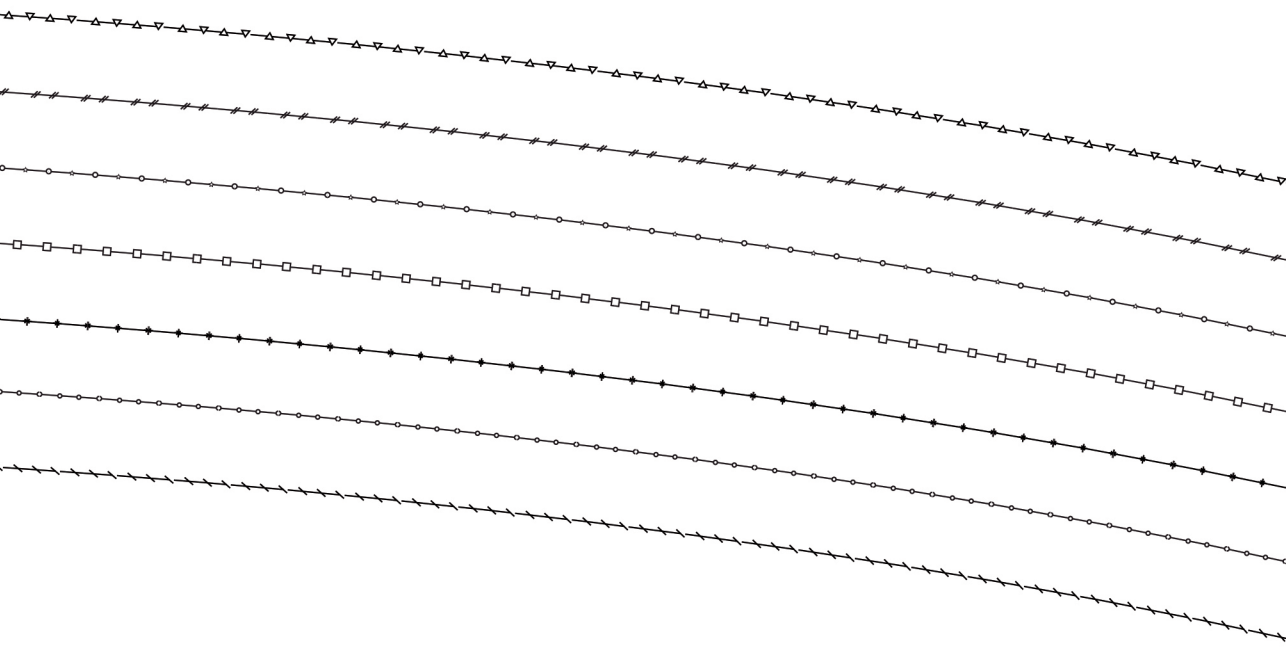

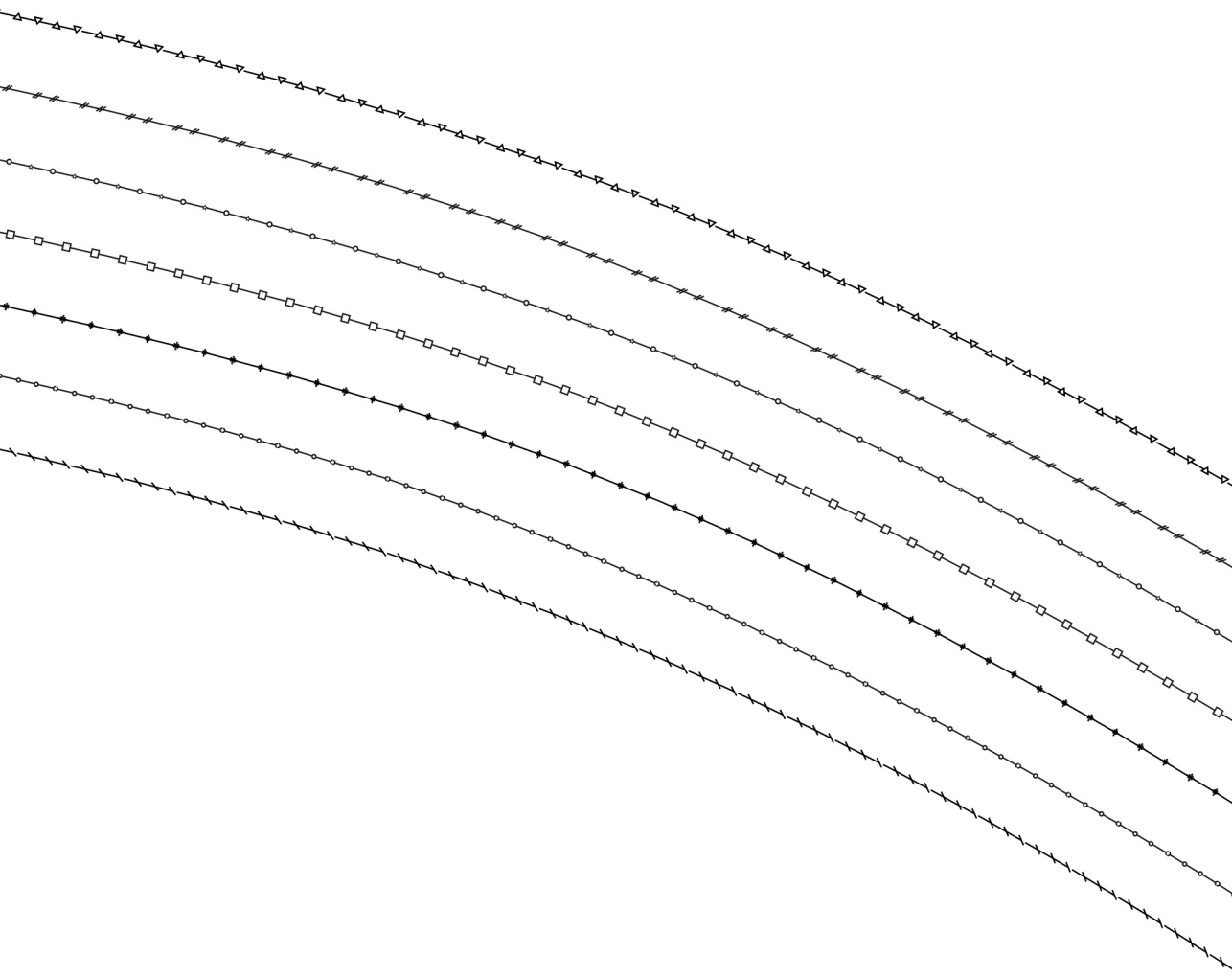



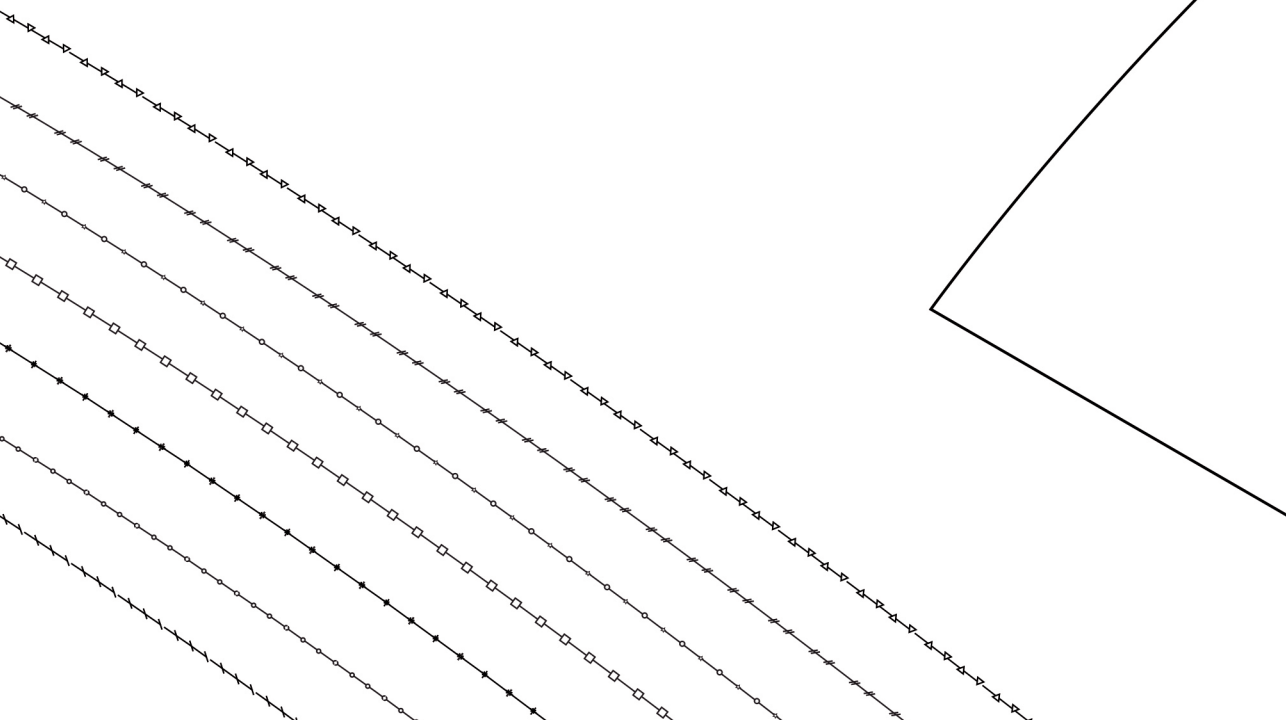

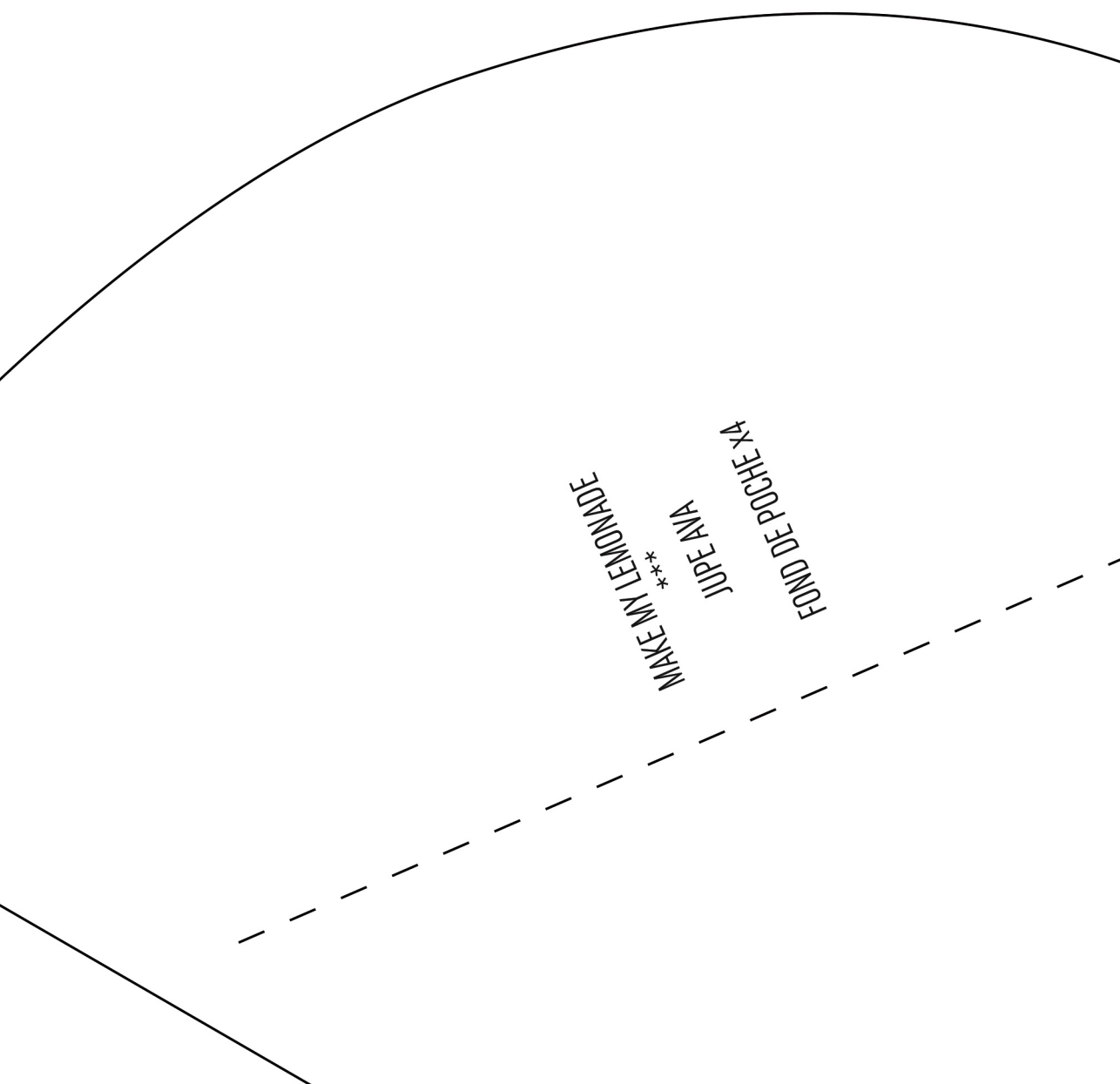

FOND DE POCHE X4

JURE ANJA

MAKE MY LEMONADE

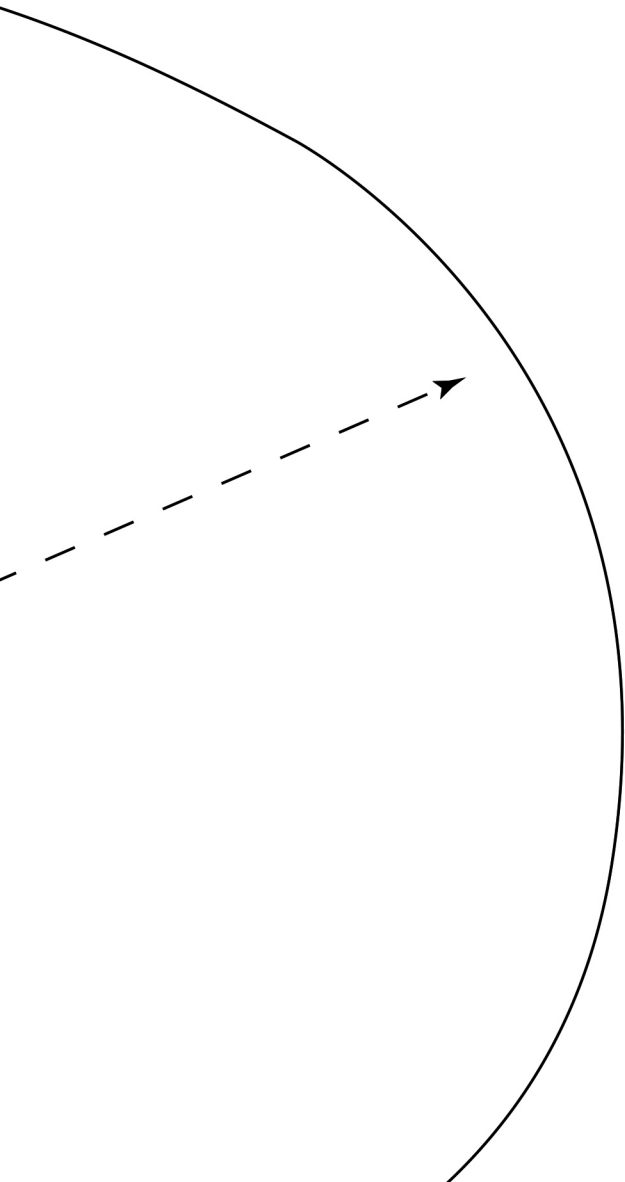

MAKE MY LEMONADE  
\*\*\*

JUPE AVA

CEINTURE DOS DESSUS x2  
(à thermocoller)

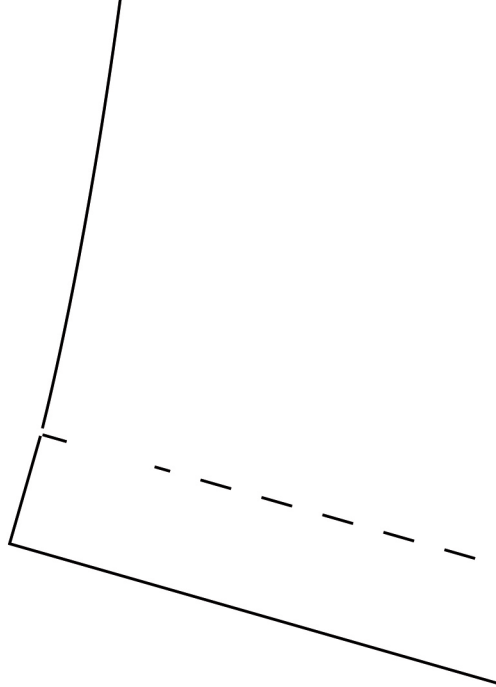
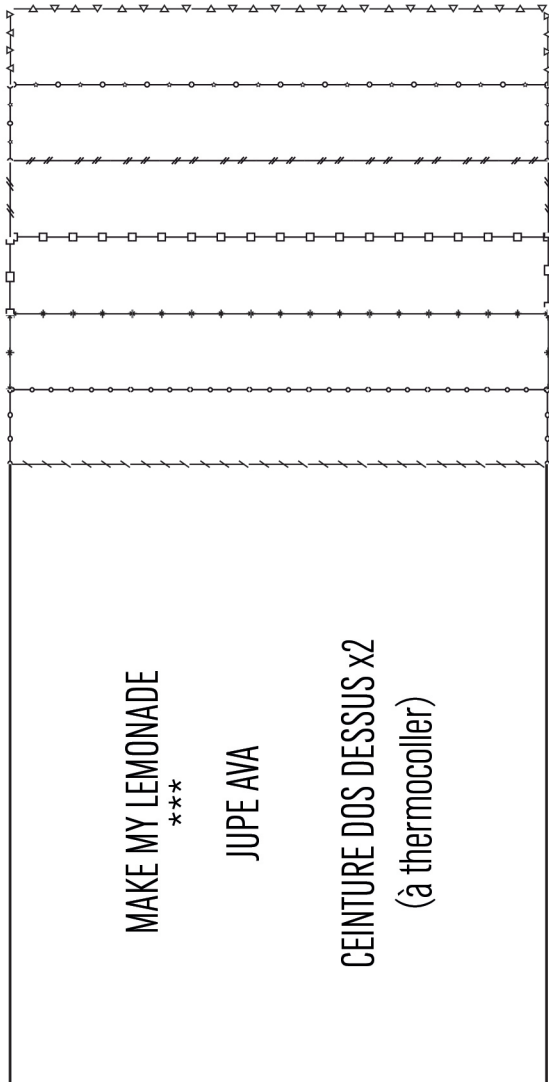

MAKE MY L  
\*\*  
JUPEA  
SOUS JUF  
DOS X2

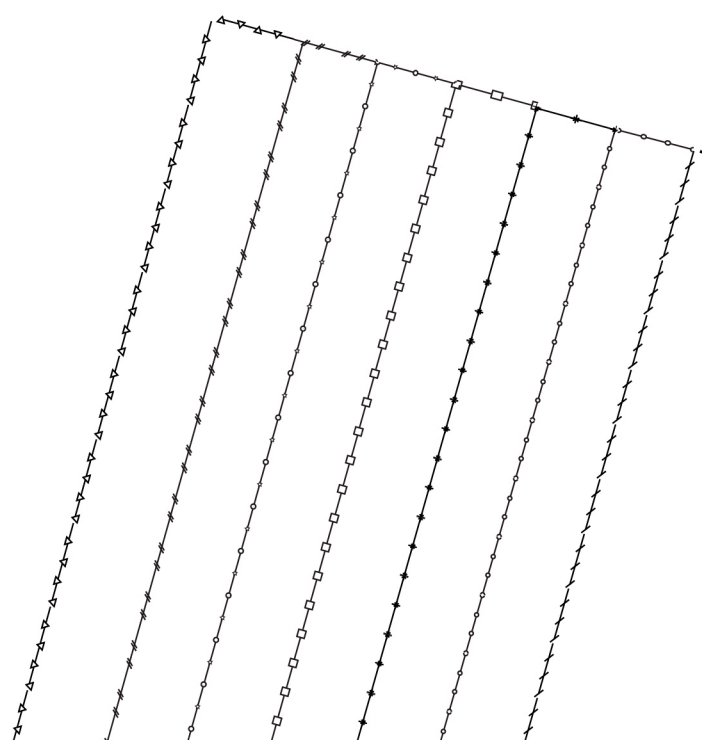
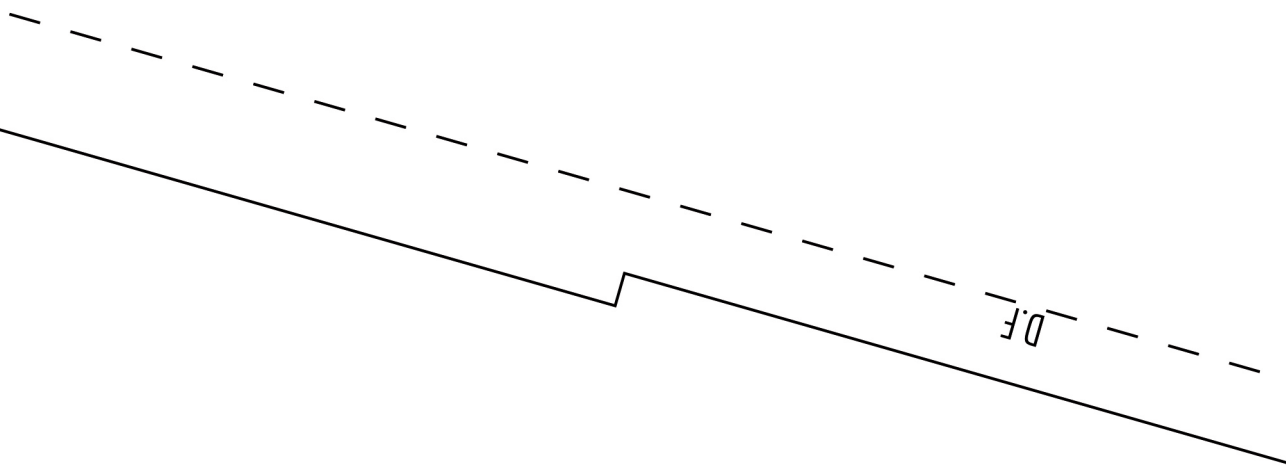
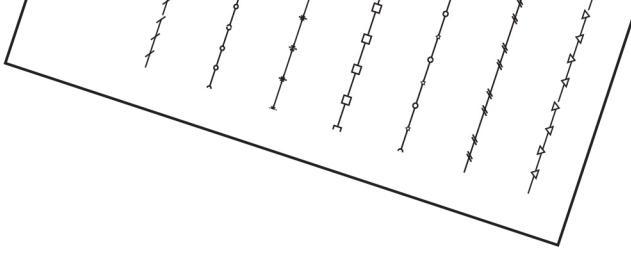

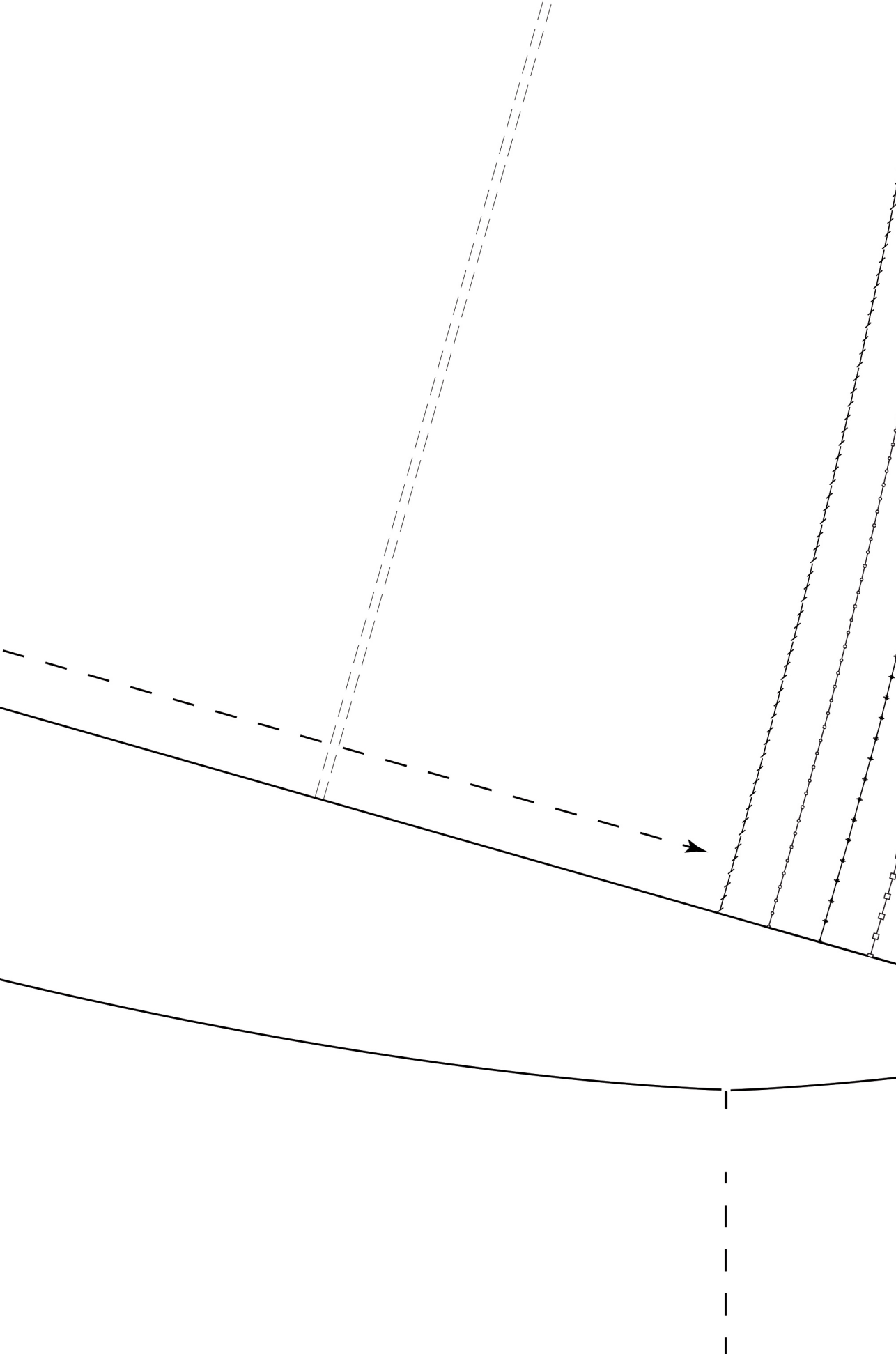

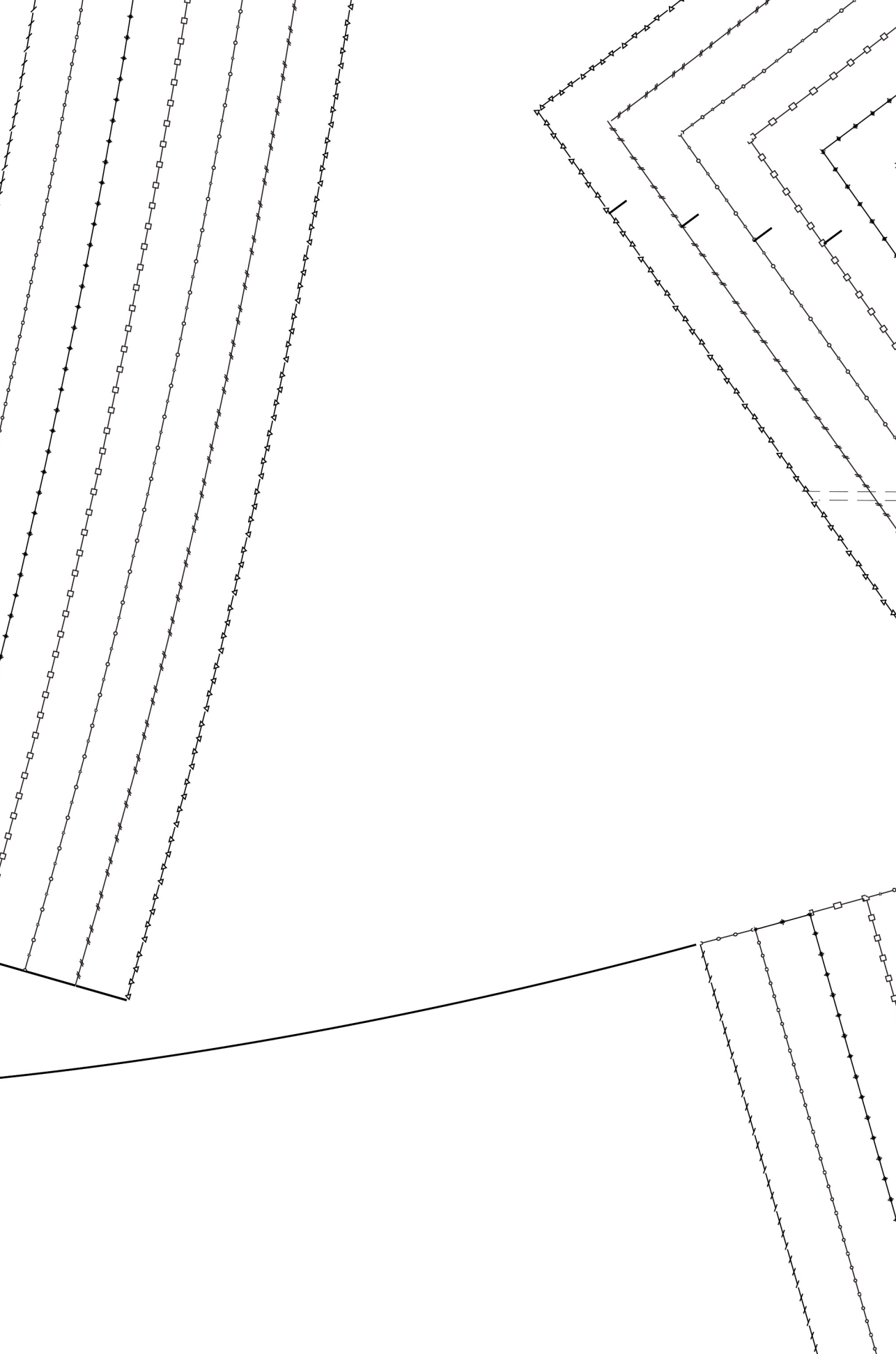

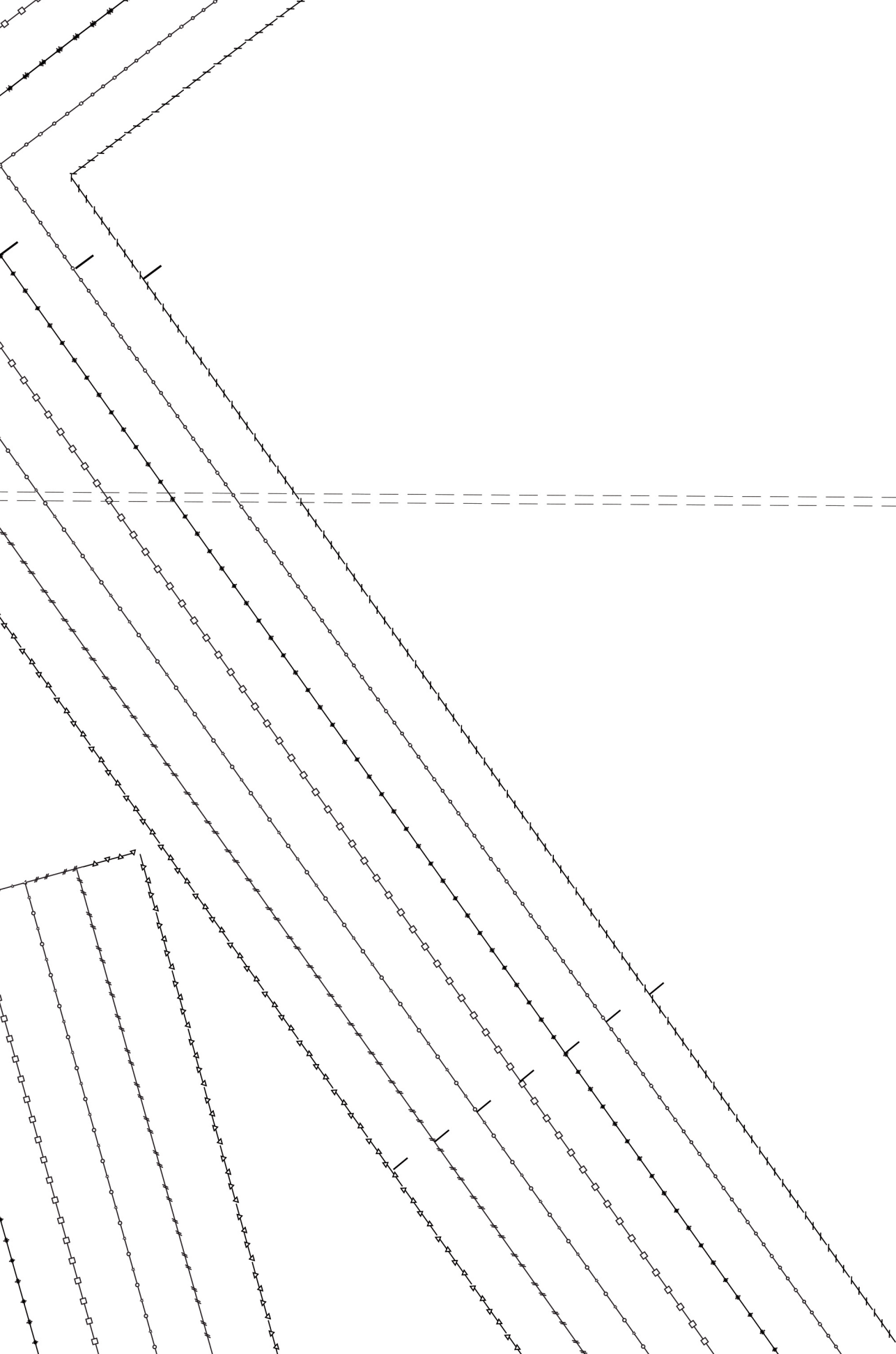



Sciez pour agrandir ou rétrécir ici!

cond

MAKE MY LEMONADE  
\*\*\*  
JUPE AVA  
DEVANT

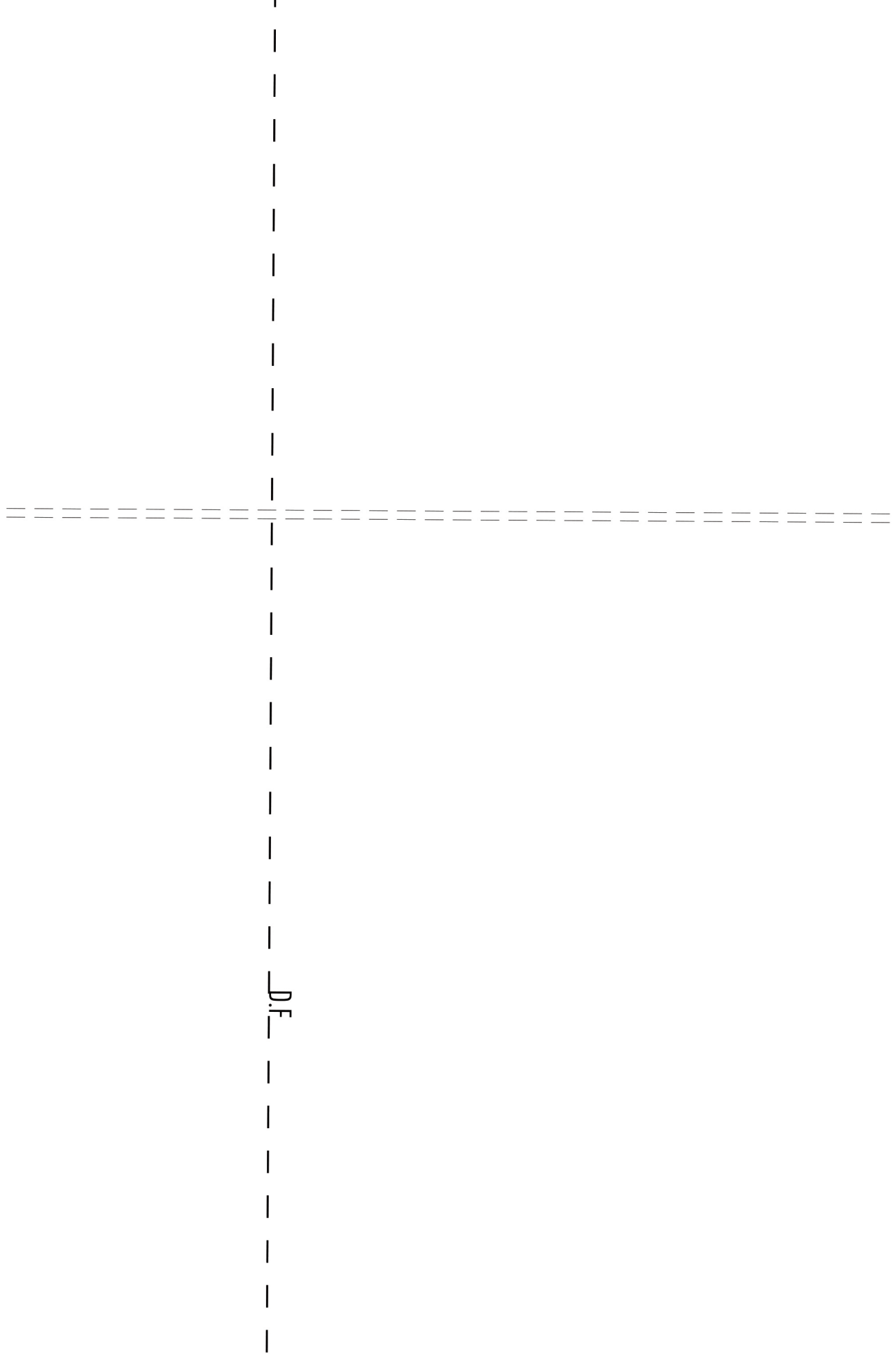

D.F.

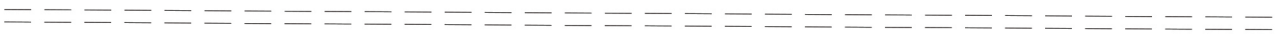

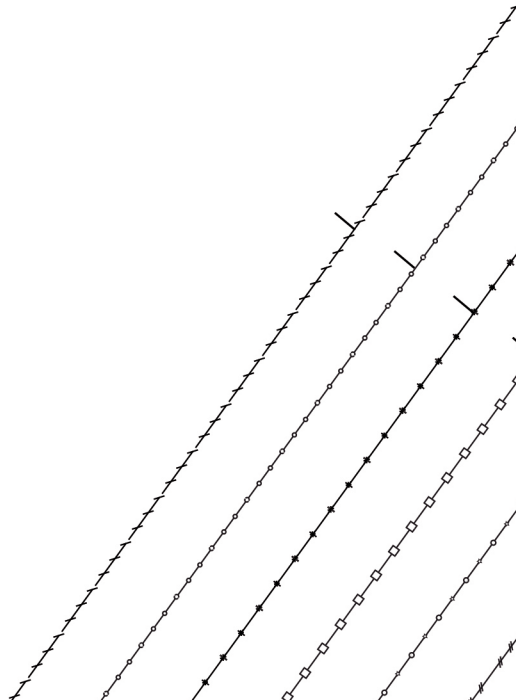
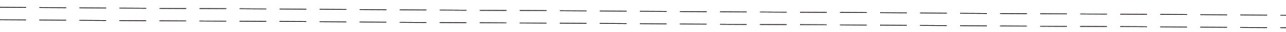

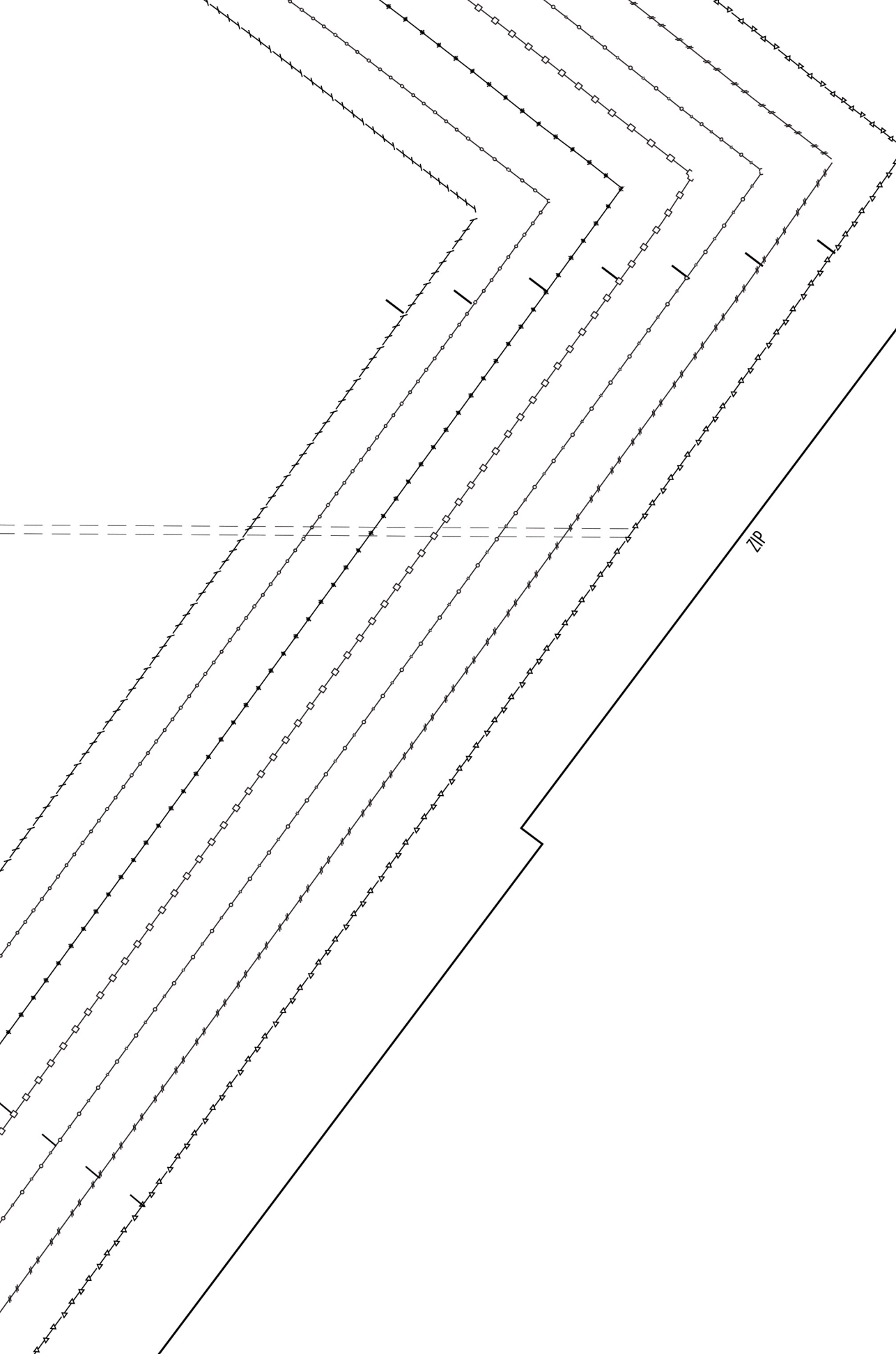

zip

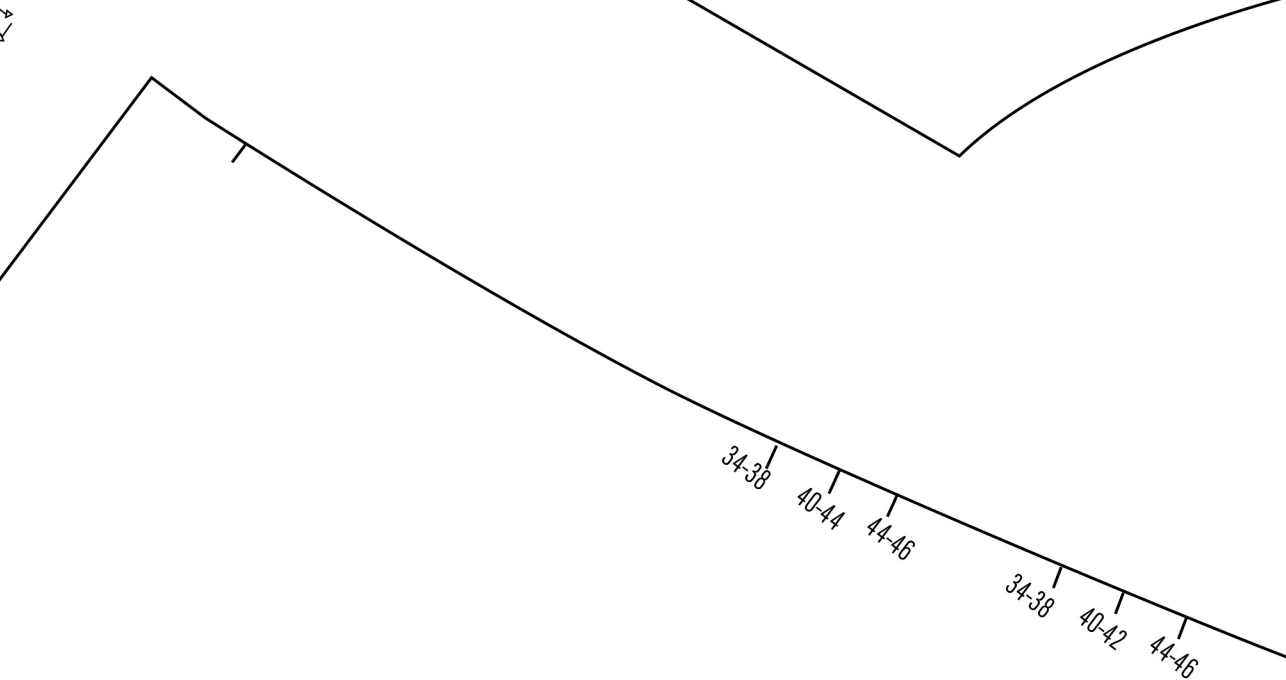

MAKE MY LEMONADE  
\*\*\*  
JUPE AVA  
DOS



34-38  
40-42  
44-46

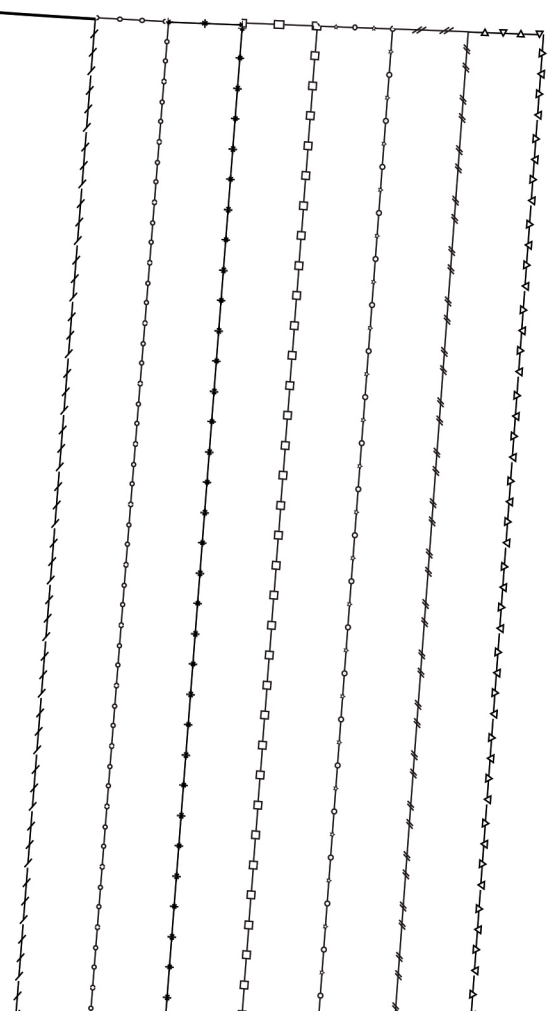



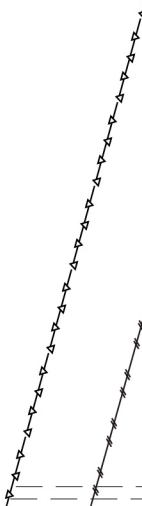
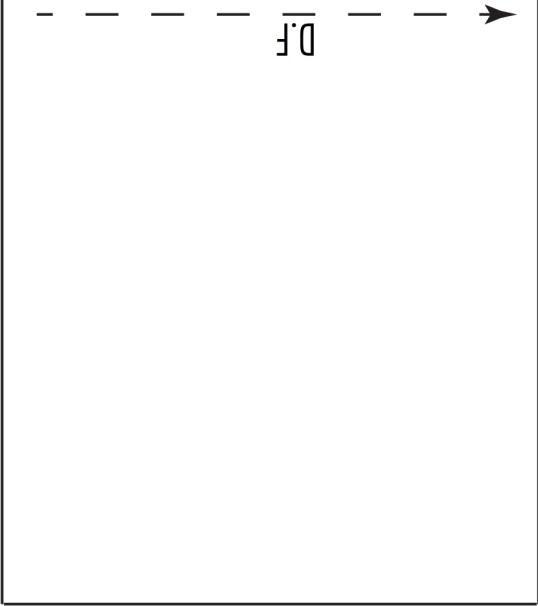

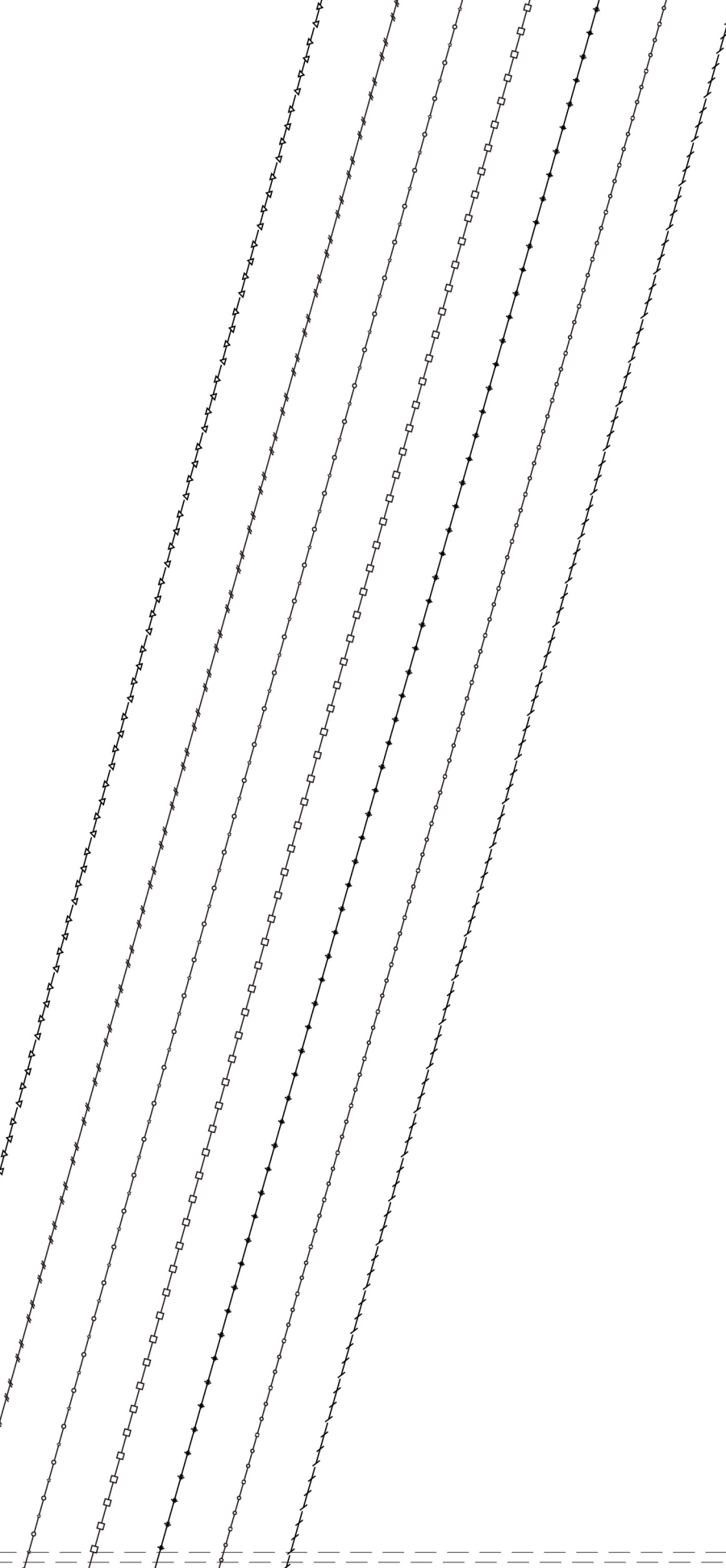

MAKE MY LEMONADE

\*\*\*

JUPE AVA  
SOUS JUPE

DEVANT

D.F



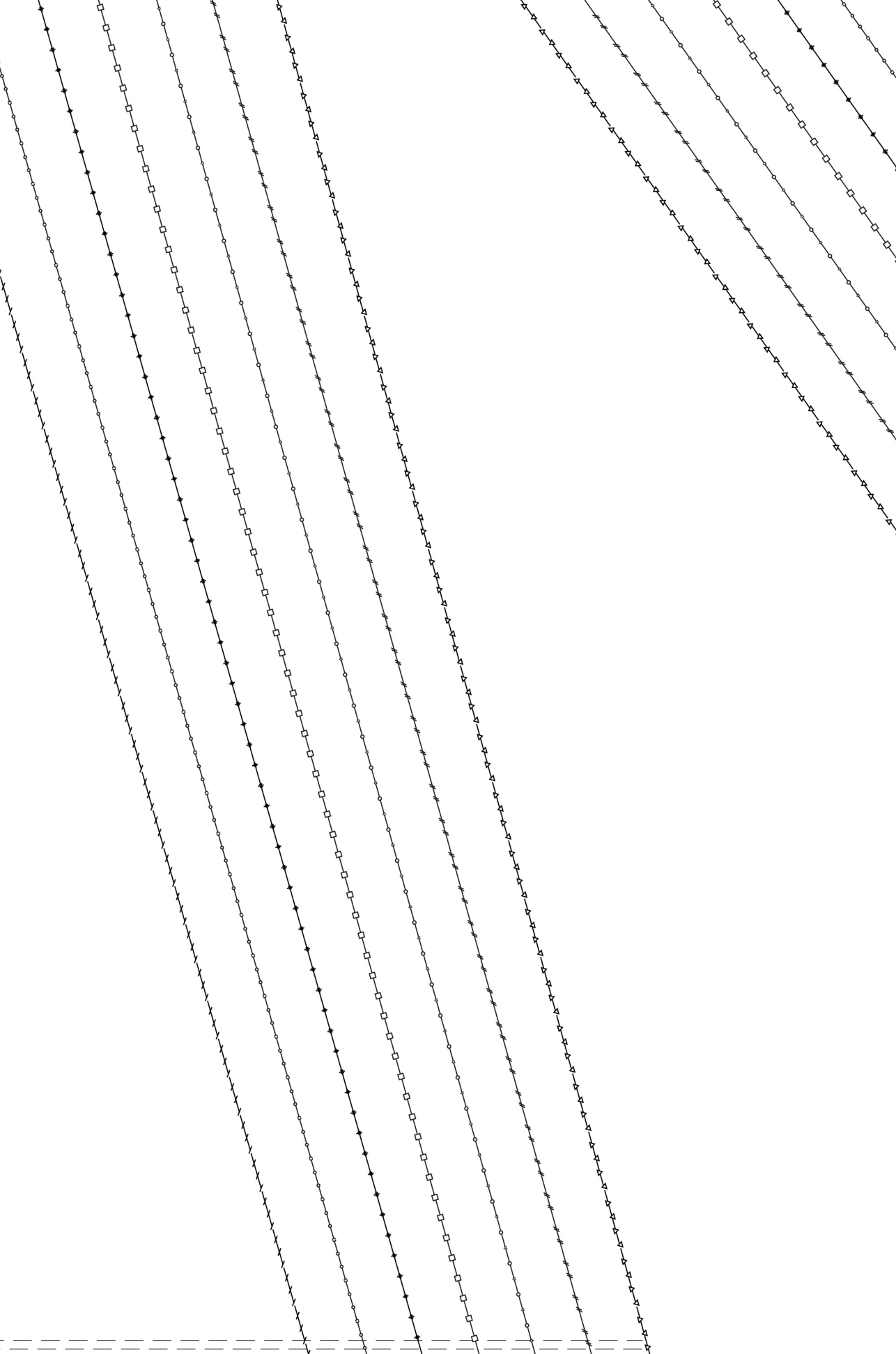

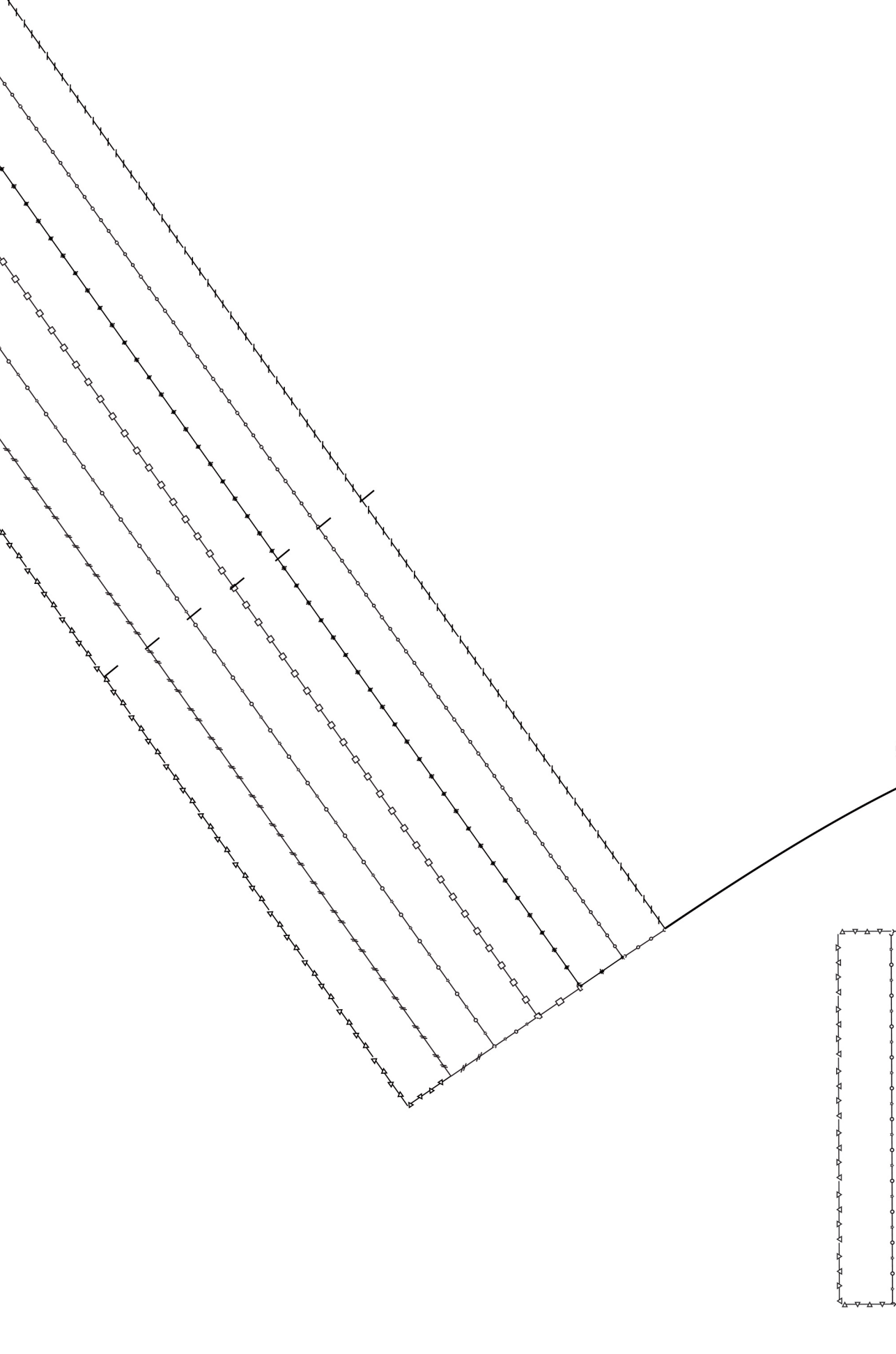

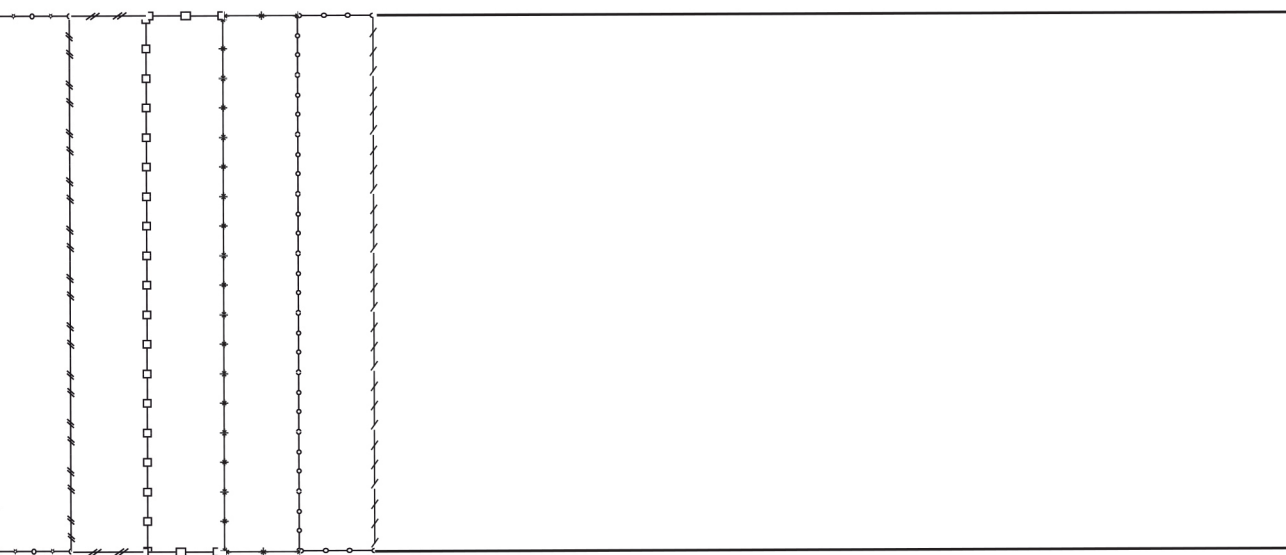
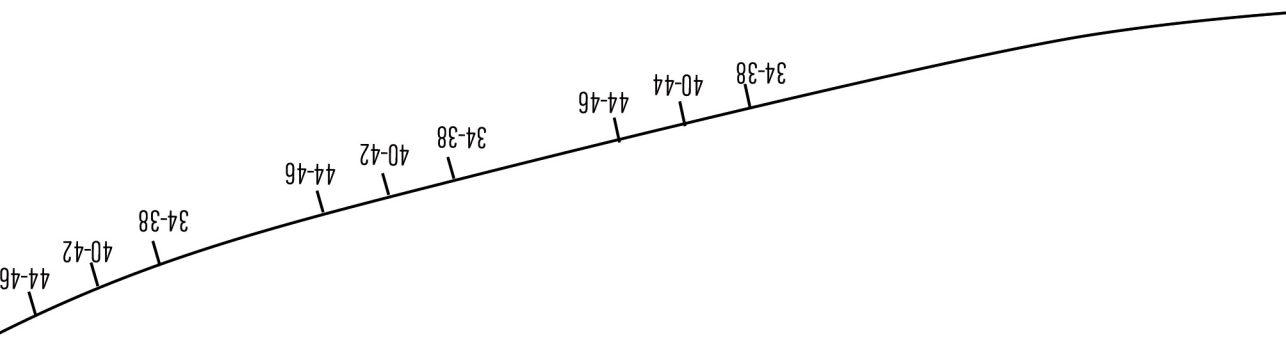

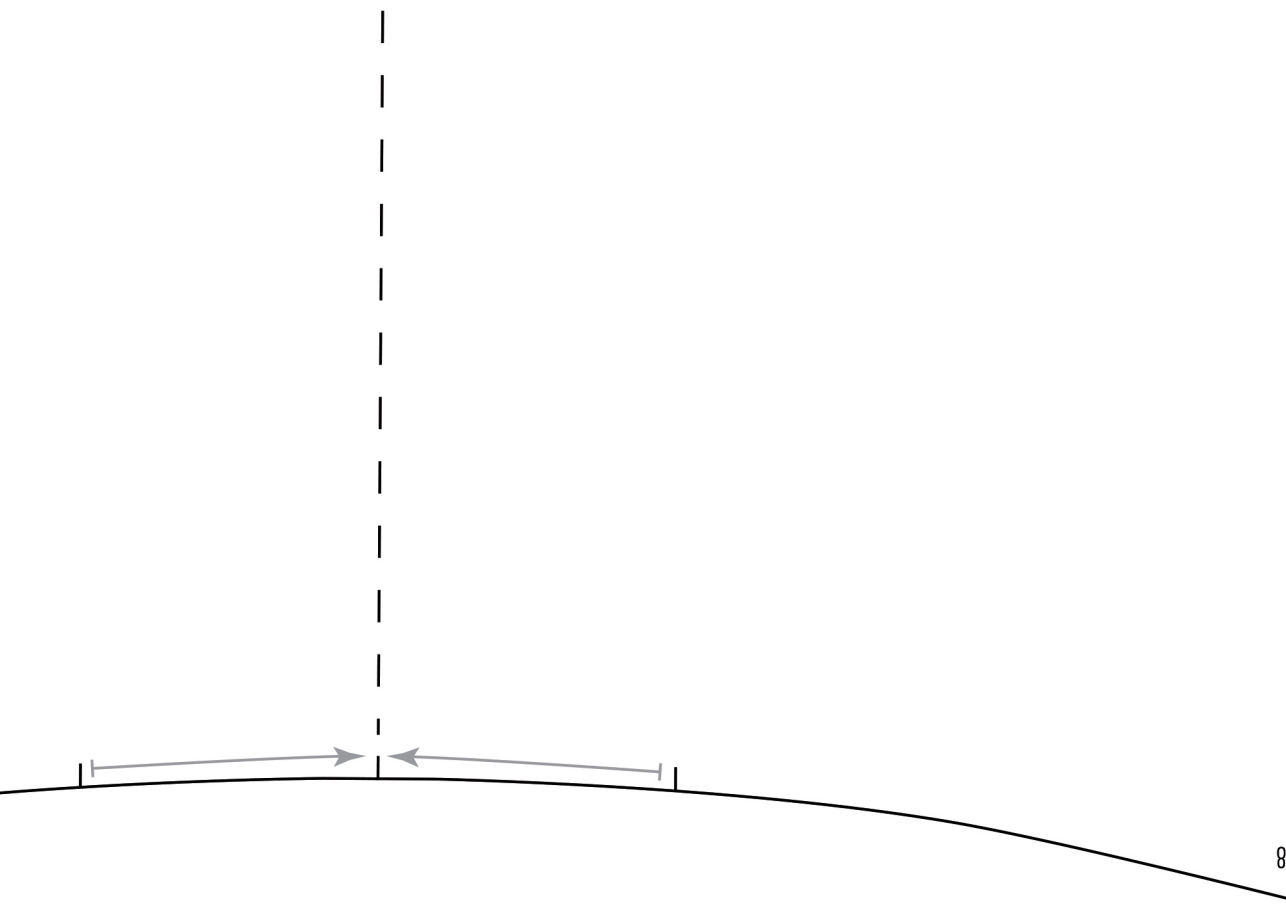

8

MAKE MY LEMONADE  
\*\*\*

JUPE AVA

CEINTURE DEVANT DESSUS  
(à thermocoller)

D.F.





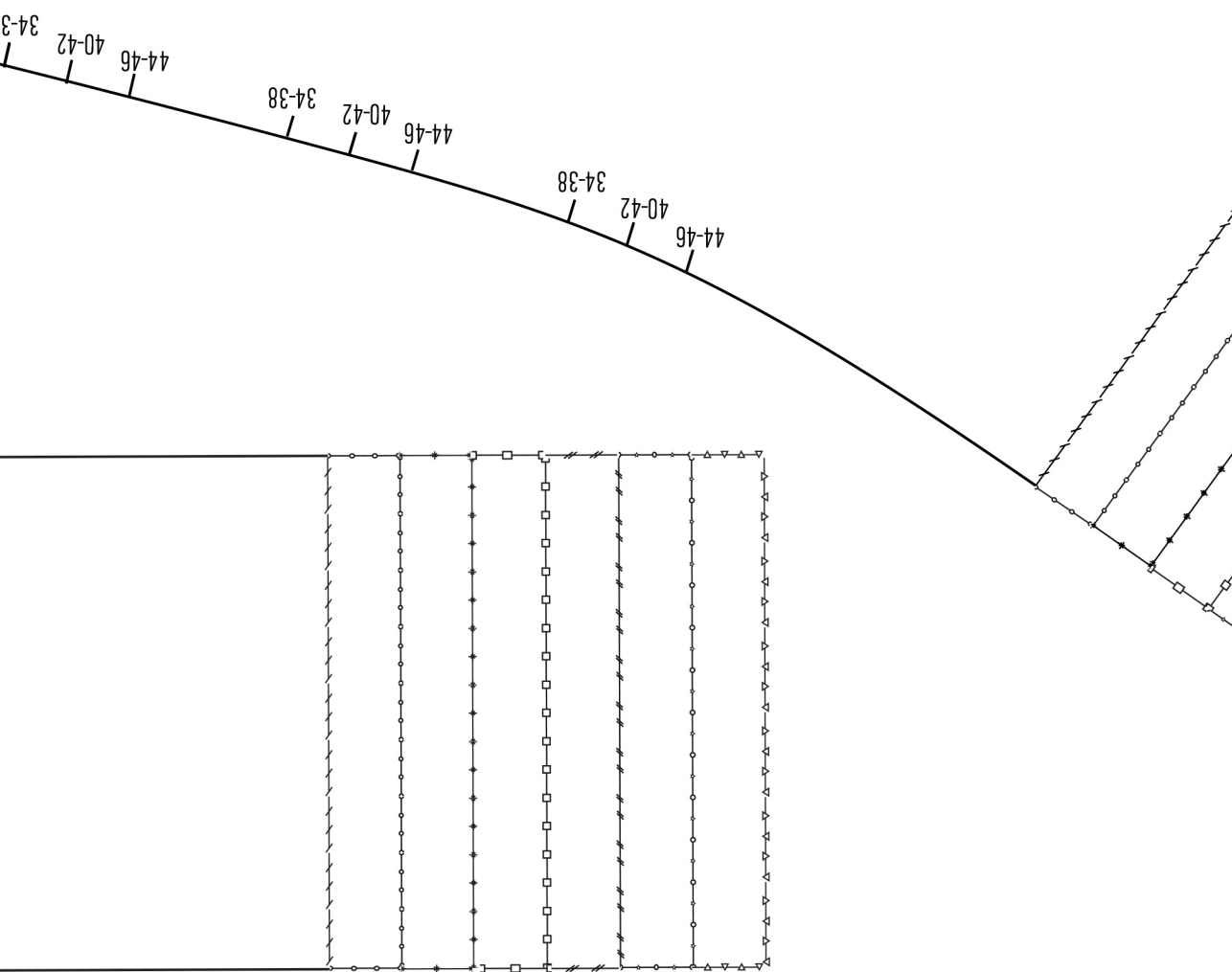

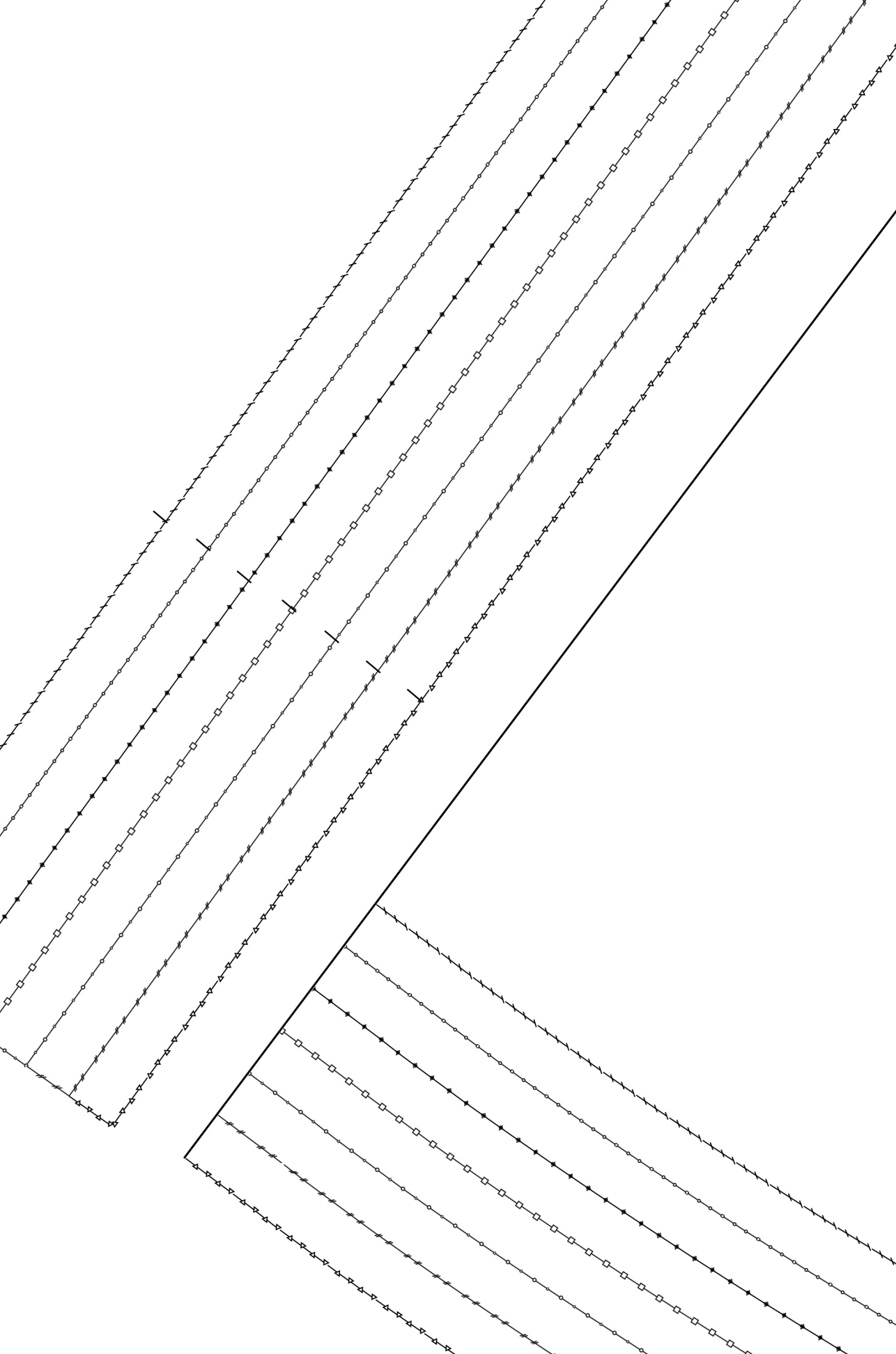

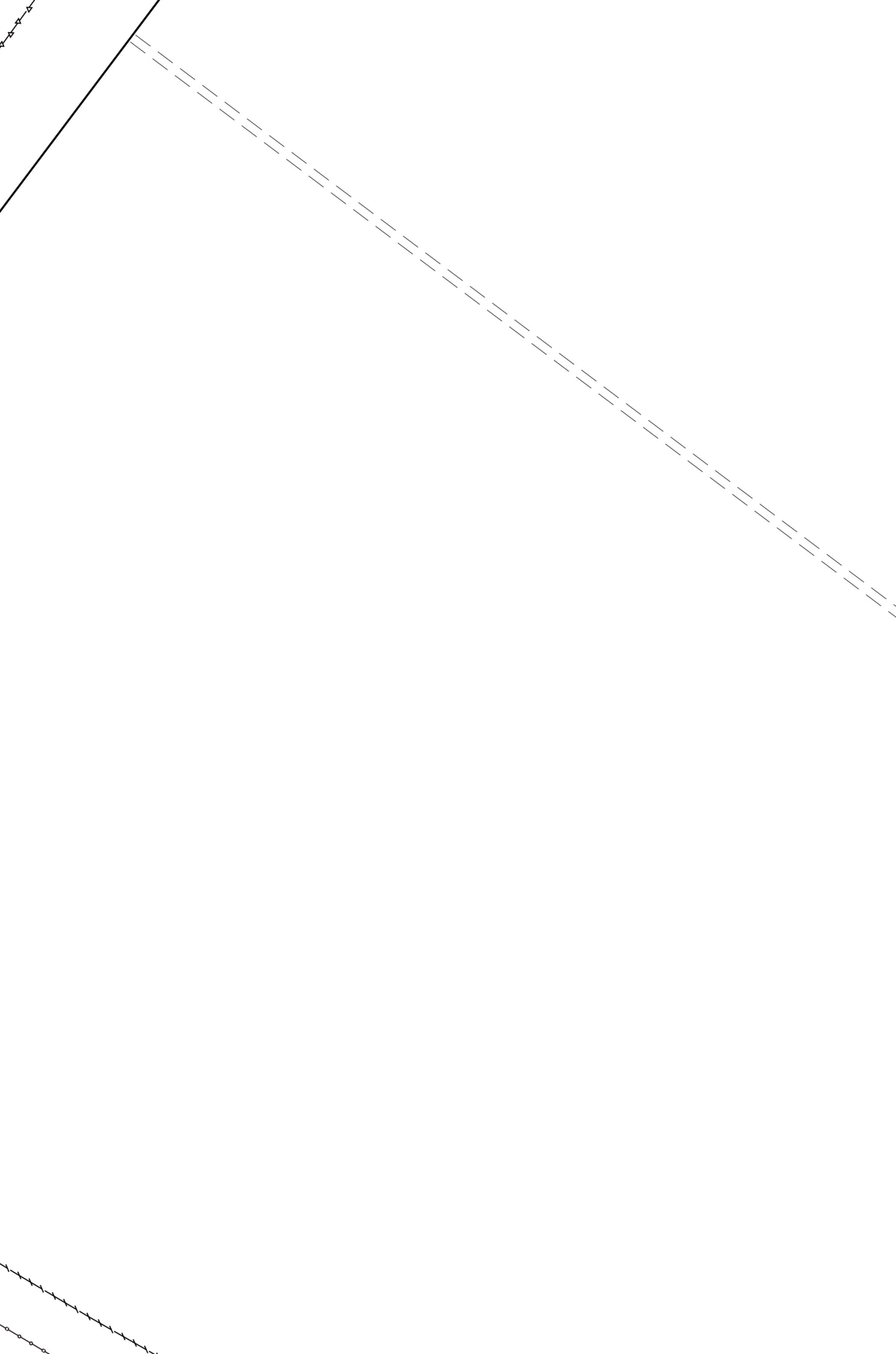

*coupez pour agrandir ou rétrécir ici*



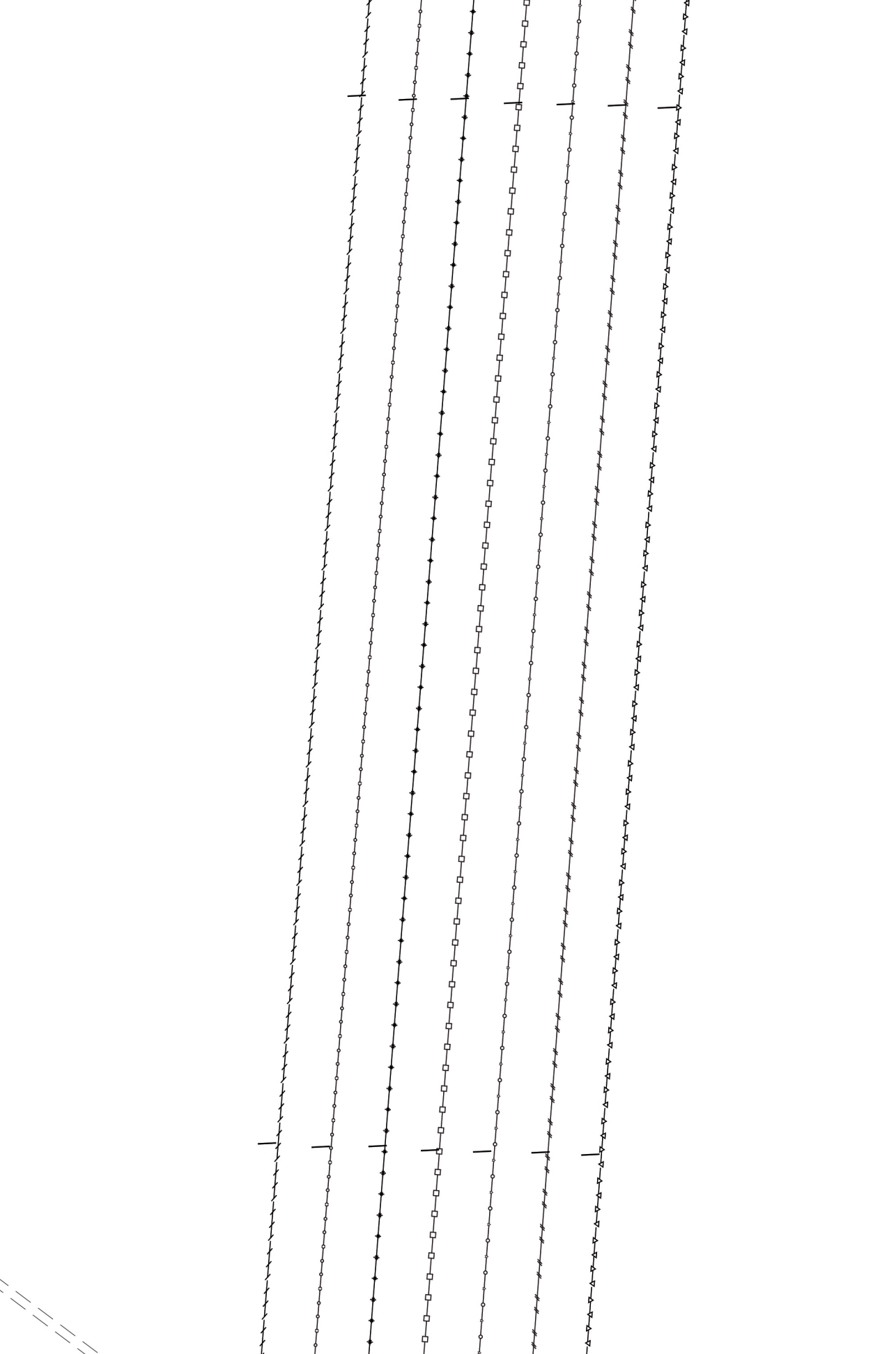

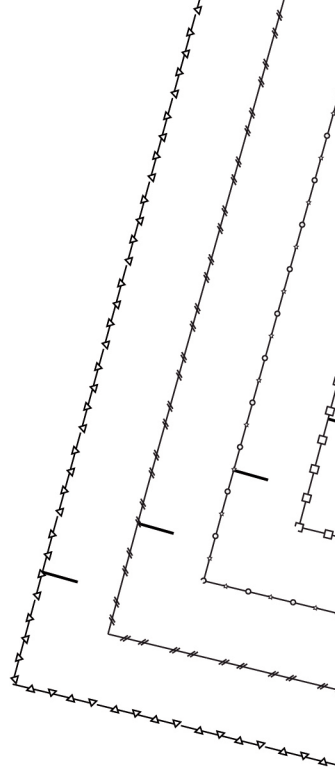

# *Wear Lemonade*

Wear Lemonade et Mak

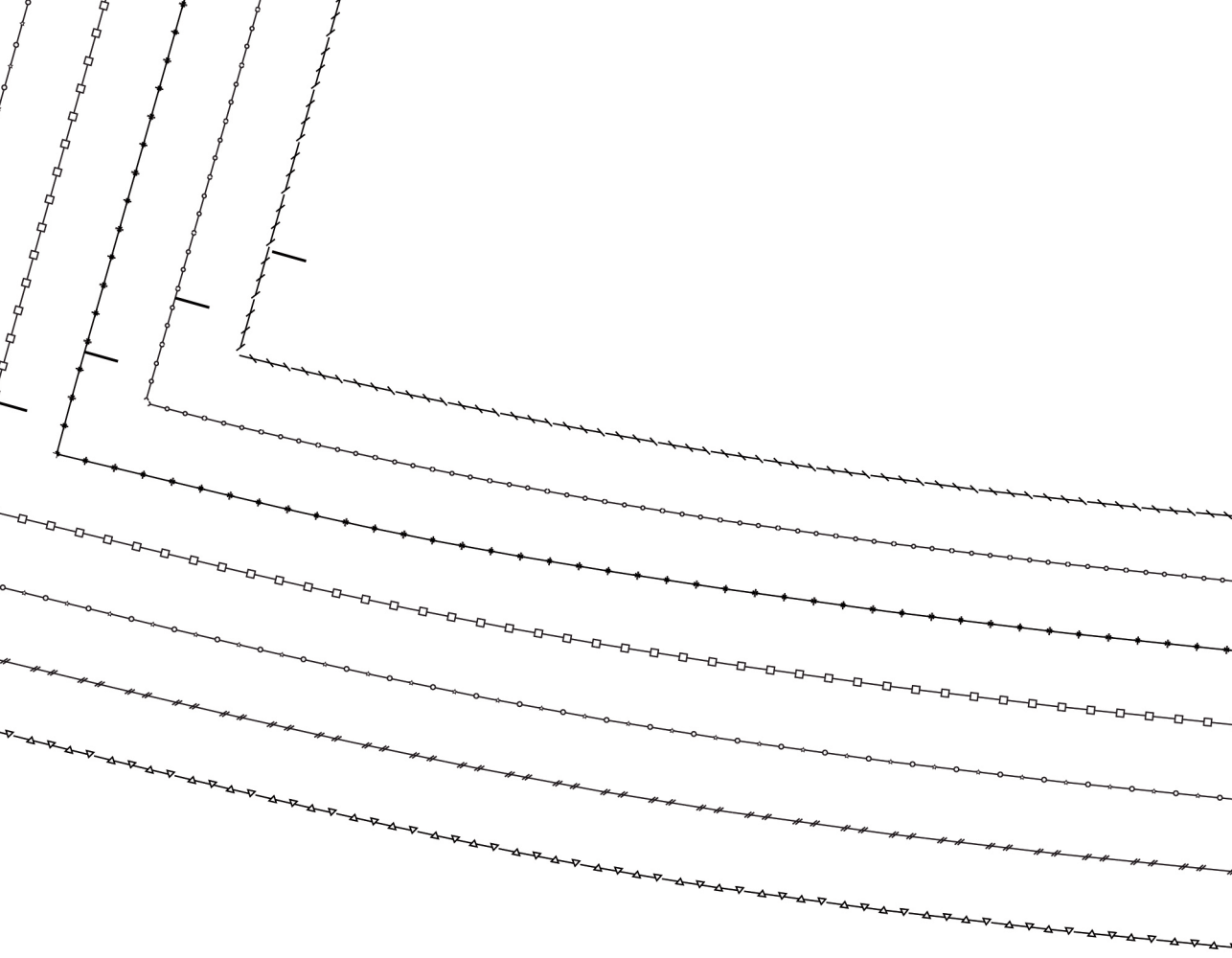

e My Lemonade sont des mar

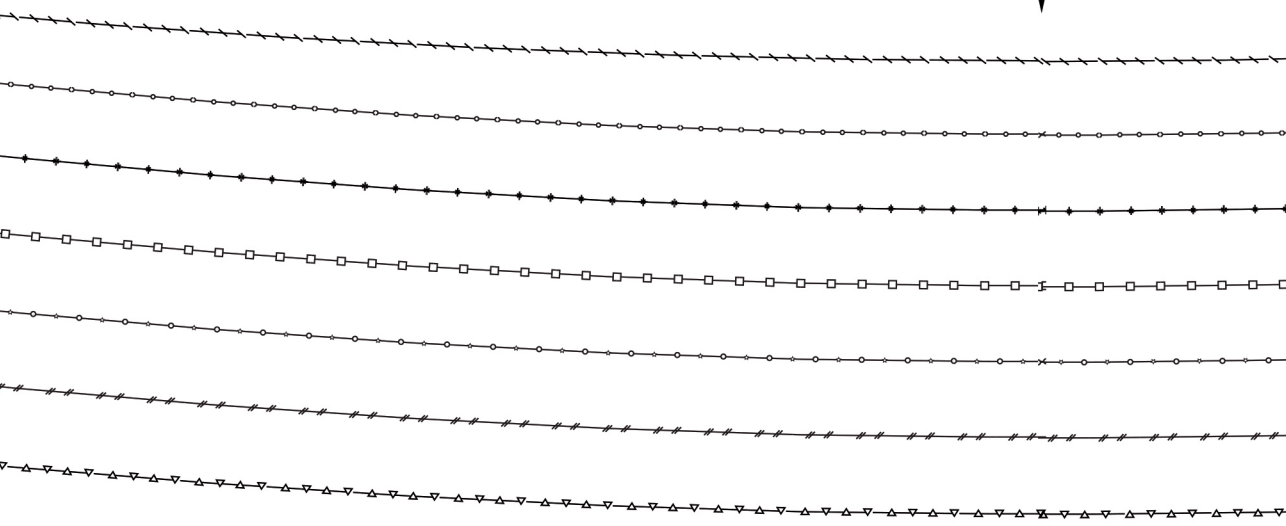

ques déposées. Tous droits réservés.



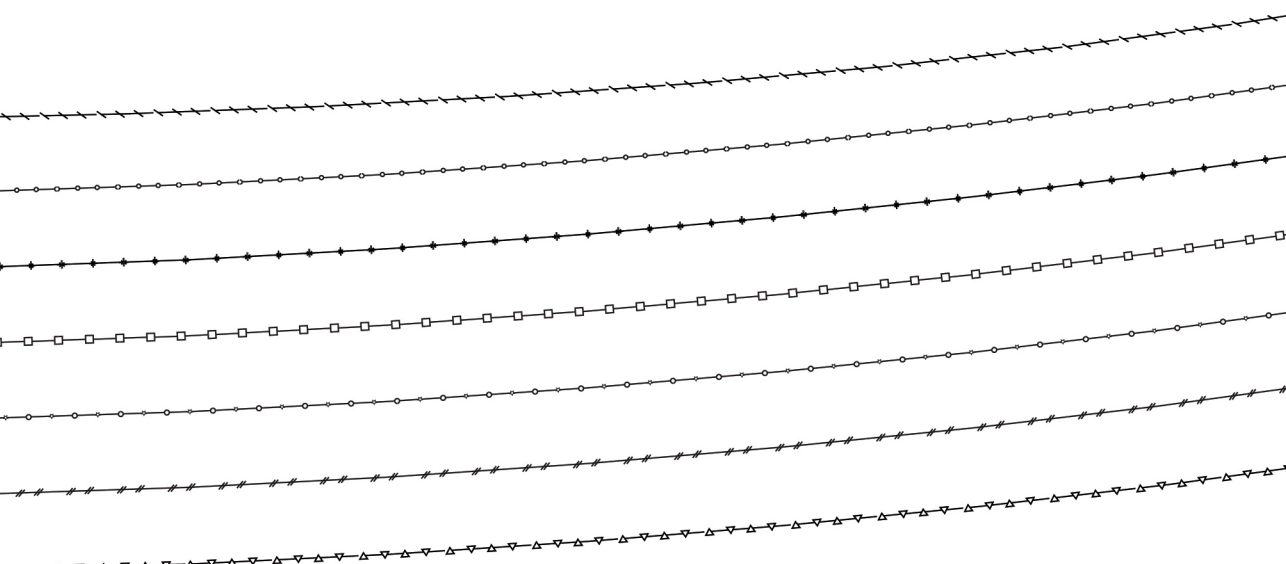

servés Copyright © 2013 WW

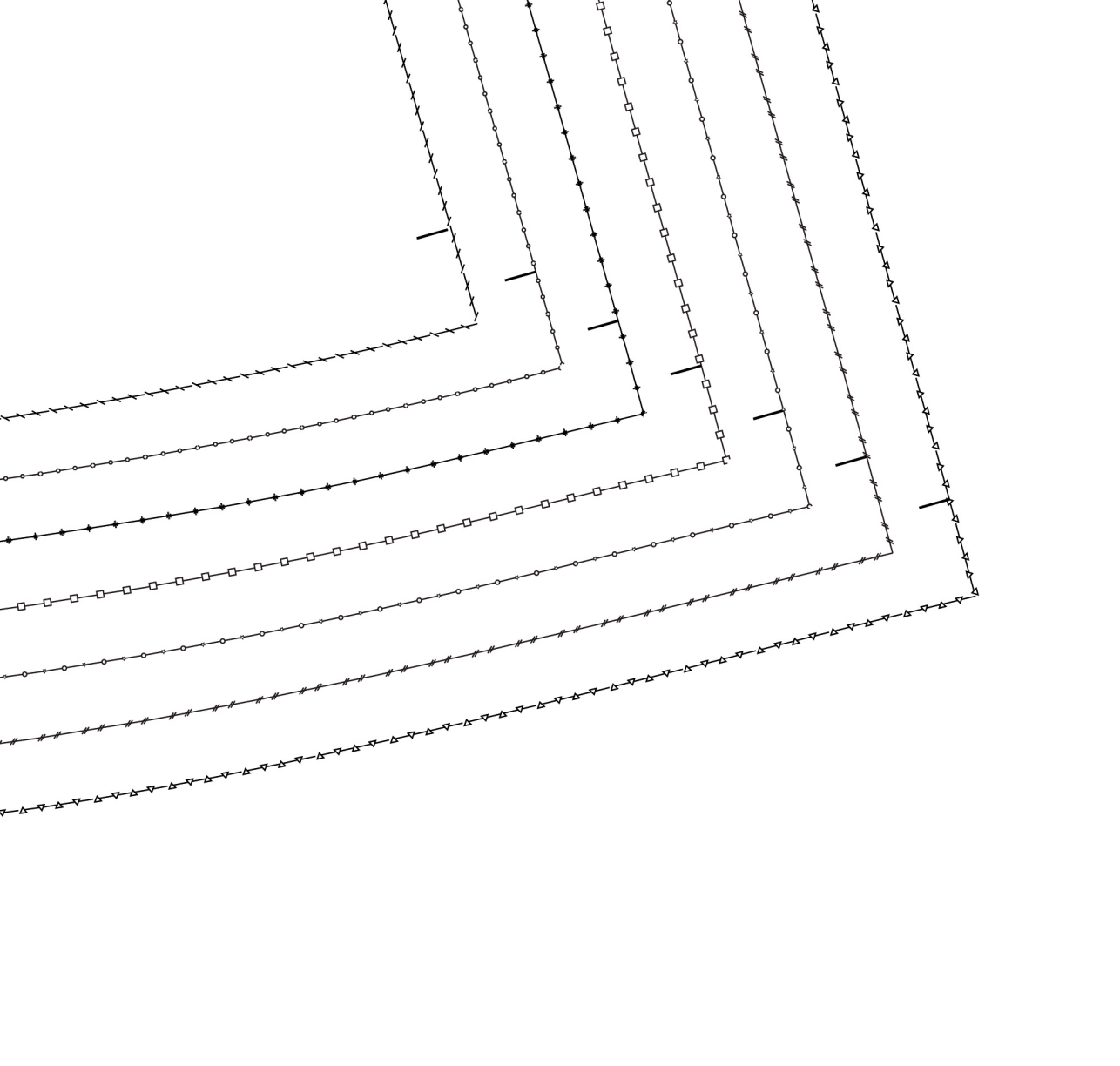

[WWW.MAKEMYLEMONADE.COM](http://WWW.MAKEMYLEMONADE.COM) -

MILIEU DOS

D.F.



MAKE MY LEMONADE

\*\*\*

JUPE AVA

CEINTURE DOS DESSOUS

[WWW.WEARLEMONADE.COM/FR](http://WWW.WEARLEMONADE.COM/FR)

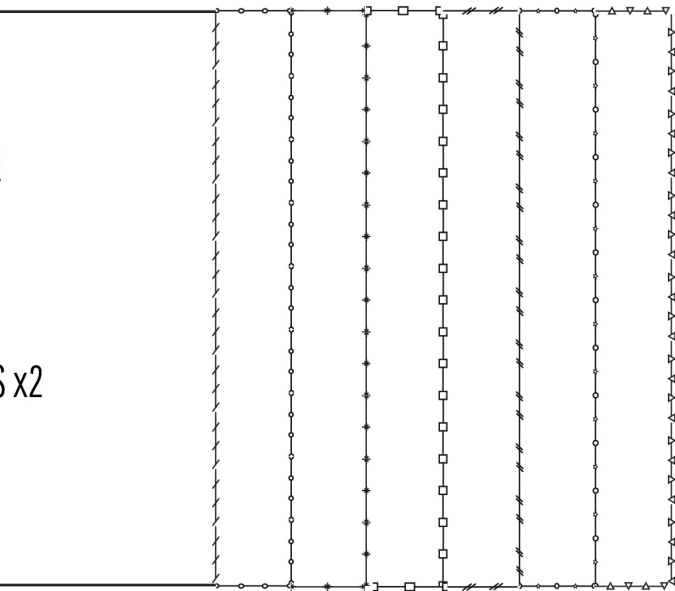

S x2

R/- JUPE AVA

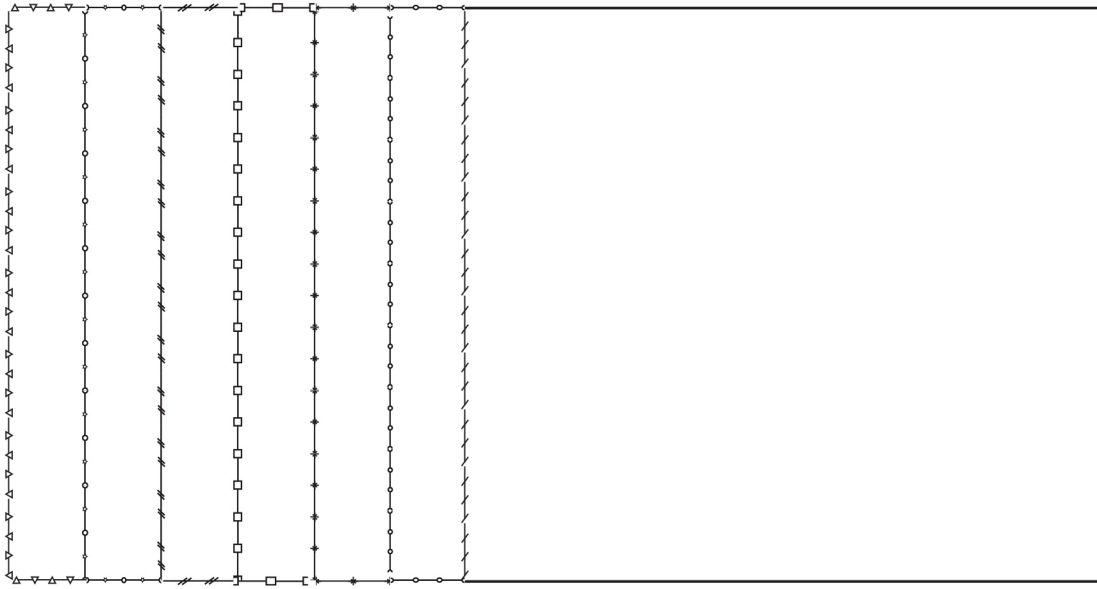

---

MAKE MY LEMONADE  
\*\*\*

JUPE AVA

CEINTURE DEVANT DESSOUS

D.F.



